

UNCLASSIFIED

Page 1 redacted for the following reason:

(b)(5)



DEPARTMENT OF THE ARMY  
 463RD MILITARY POLICE COMPANY  
 CAMP LIBERTY, IRAQ, AE 09344

IMNW-LNW-ESG

24 OCTOBER 2006

MEMORANDUM FOR RECORD

SUBJECT: Investigative chronology

DATE	EVENT / CONTACT
15 October 06	2200: Received WARNO from (b)(3), (b)(6) that I would be conducting a 15-6 informal investigation on a CF KIA with the 57th MP CO that occurred circa three days previous. I was also advised that I would be mentoring another (b)(3), (b)(6) in the completion of his 15-6. Orders will be directly from Brigade. I was also advised not to commence the investigation until after the units ceremony for the soldier.
16 October 06	I recovered the CCIR and storyboard of the incident. I am still awaiting orders from Brigade.
20 October 06	I went to the 57th MP CO TOC and briefed (b)(3), (b)(6) on my appointment, as well as offered my condolences. I also allowed him to read my appointment order. (b)(3), (b)(6) indicated that cursory efforts to obtain Sworn Statements et al had begun after last evenings ceremony. (b)(3), (b)(6) indicated that (b)(3), (b)(6) is the (b)(3), (b)(6) for the element that was attacked. I met with (b)(3), (b)(6) and briefed him up as I had (b)(3), (b)(6). I asked that Sworn Statements and Privacy Act Statements be taken from anyone with first hand knowledge of the attack. (b)(3), (b)(6) indicated that I could pick up the completed Sworn Statements and Privacy Act Statements at 0900 on 21 October 06. ** (b)(3), (b)(6) in the GT attacked is presently in Hawaii convalescing, I will call (b)(3), (b)(6) to determine if her statement et al are imperative.
21 October 06	I went to the 57th MP CO TOC at 0900 to pick up the Sworn Statements et al as instructed by (b)(3), (b)(6) was not there and no information was left there for me. I was told that (b)(3), (b)(6) would be in that afternoon. //////////////////////////////////////next page////////////////////////////////////

<p>21 October 06</p>	<p>1600: After several attempts to linkup with (b)(3), (b)(6) finally located him (b)(3), (b)(6) handed this writer 6 Privacy Act Statements and requested a couple more blank copies.                  1605: I provide (b)(3), (b)(6) a blank copy of a Privacy Act Statement and reiterated my request for that any person having first hand knowledge of the attack should complete a Sworn Statement and Privacy Act Statement. (b)(3), (b)(6) assured this writer that the requested information would be completed and ready for pick up at the 57th TOC NLT 221200LOCT 06.</p>
<p>22 October 06</p>	<p>1500: I went to the 57th TOC and recovered the aforementioned documents (20 pages (10 front and back)</p>
<p>22 October 06</p>	<p>1600: I sent an e-mail to (b)(3), (b)(6) RFI: Are the Sworn Statement and Privacy Act Statement of (b)(3), (b)(6) of the GT attacked, an imperative prior to completing this investigation. Subsequent telephone conversation with (b)(3), (b)(6) in this issue indicated that the aforementioned statements were desired but not required. Due to time constraints and having sufficient basis for findings and recommendations I will complete the investigation at this time.</p>

Encl

(b)(3), (b)(6)



DEPARTMENT OF THE ARMY  
372ND MILITARY POLICE BATTALION  
CAMP LIBERTY, IRAQ, APO AE 09344

IMNW-LNW-ESG

24 OCTOBER 2006

## MEMORANDUM FOR RECORD

SUBJECT: 15-6 Investigation on Stanton, Kenny F. Jr., (b)(3), (b)(6) (KIA)

1. The following is a memorandum for record into the 15-6 Investigation conducted by (b)(3), (b)(6) into the matter of Kenny F. Stanton, SSN: (b)(3), (b)(6) KIA on 13 October 2006.

2. Investigation into this matter has established the following findings of fact:

On 132110COCT06 Centurion 1-2, consisting of vehicles 57-121, 57-124, 57-133, and 57-134, were conducting an authorized mounted patrol in the Kadhimiyah District. (See Exhibit II, pages 1, 3, and 5).

While traveling on Route Mets elements of Centurion 1-2 observed suspicious activity to wit: "two IP patrol vehicles escorting a black BMW behind our convoy", after being detected the aforementioned suspicious turned off onto Creek Road, turned off the running lights and disappeared. (See Exhibits X and XII).

Given the foregoing suspicious activity the Centurion 1-2 element turned onto Creek Road heading East. (See Exhibit II, pages 1, 3, 5, and 6).

At 132057COCT06 Centurion 1-2 Gun Truck 57-133 was struck on the drivers side with what is believed to have been an IED / EFP. (See Exhibit II, pages 5, 6, 7, and 8).

The driver of 57-133, Kenny F. Stanton was KIA "immediately", due to "explosive trauma" to the mandible and throat. (See Exhibit III, pages 1, 2, and 3. Exhibit IV, page 1. Exhibit XII).

The (b)(3), (b)(6) and (b)(3), (b)(6) were administered first aid and Centurion 1-1 ground MEDEVAC said personnel to the 10th CSH. (See Exhibit II, pages 2, 3, and 5. Exhibit X, Exhibit XII, Exhibit XIV, Exhibit XVI, Exhibit XVIII, and Exhibit XX).

Page 1 of 2

Centurion 1-2 set up a cordon to support recovery operations and MEDEVAC. (See Exhibits VI, VIII, XIV, XVI, XVIII, and XX.)

All soldiers in the attacked vehicle, (57-133), et al were wearing all PPE. (See Exhibit IV, pages 1, 2, and 4. Exhibits VI, VIII, XIV, XVI, XX, XXII, and XXIV).

All IED defeat jamming system were operational and engaged ( (b)(1)1.4a )  
(See Exhibits VI, VIII, XIV, XVI, XX, XXII, and XXIV).

For timeline refer to Exhibit II (Page 5).

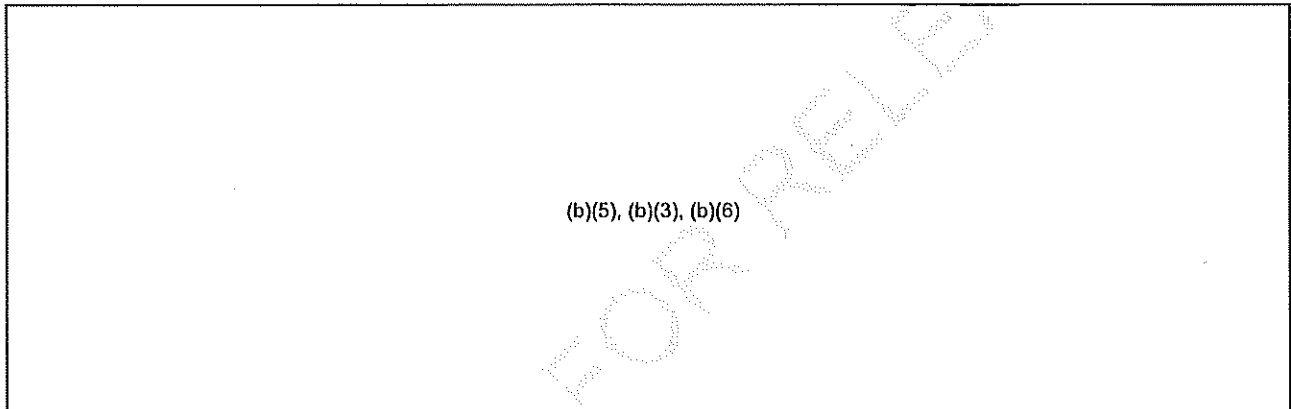



DEPARTMENT OF THE ARMY  
372ND MILITARY POLICE BATTALION  
CAMP LIBERTY, IRAQ, AE 09344

IMNW-LNW-ESG

24 OCTOBER 2006

MEMORANDUM FOR RECORD

SUBJECT: Exhibit Memo

1. The following is a list of exhibits regarding the 15-6 investigation conducted on the 57th MP Company. Relative to Stanton, Kenny F. Jr., (b)(3), (b)(6)

Exhibit I: APPOINTMENT ORDERS

Exhibit II: CCIR #3040, STORYBOARD W/ PICTURES (10 pages).

Exhibit III: CERTIFICATE OF DEATH (DD-2064)- "DRAFT" (7 PAGES).

Exhibit IV: "CJTF7 CASUALTY REPORT FORM" (6 PAGES).

Exhibit V: PRIVACY ACT STATEMENT- (b)(3), (b)(6)

Exhibit VI: SWORN STATEMENT (b)(3), (b)(6)

Exhibit VII: PRIVACY ACT STATEMENT (b)(3), (b)(6)

Exhibit VIII: SWORN STATEMENT (b)(3), (b)(6)

Exhibit IX: PRIVACY ACT STATEMENT (b)(3), (b)(6)

Exhibit X: SWORN STATEMENT (b)(3), (b)(6)

Exhibit XI: PRIVACY ACT STATEMENT (b)(3), (b)(6)

Exhibit XII: SWORN STATEMENT (b)(3), (b)(6)

Exhibit XIII: PRIVACY ACT STATEMENT (b)(3), (b)(6)

Exhibit XIV: SWORN STATEMENT (b)(3), (b)(6)

Exhibit XV: PRIVACY ACT STATEMENT (b)(3), (b)(6)

Exhibit XVI: SWORN STATEMENT (b)(3), (b)(6)

Exhibit XVII: PRIVACY ACT STATEMENT (b)(3), (b)(6)

Exhibit XVIII: SWORN STATEMENT (b)(3), (b)(6)

Exhibit XIX: PRIVACY ACT STATEMENT [redacted] (b)(3), (b)(6)

[redacted] (b)(3), (b)(6)

Exhibit XX: SWORN STATEMENT [redacted] (b)(3), (b)(6)

[redacted] (b)(3), (b)(6)

Exhibit XXI: PRIVACY ACT STATEMENT [redacted] (b)(3), (b)(6)

[redacted] (b)(3), (b)(6)

Exhibit XXII: SWORN STATEMENT [redacted] (b)(3), (b)(6)

Exhibit XXIII: PRIVACY ACT STATEMENT [redacted] (b)(3), (b)(6)

[redacted] (b)(3), (b)(6)

Exhibit XXIV: SWORN STATEMENT [redacted] (b)(3), (b)(6)

[redacted] (b)(3), (b)(6)

[redacted] (b)(3), (b)(6)

**REPORT OF PROCEEDINGS BY INVESTIGATING OFFICER/BOARD OF OFFICERS**

For use of this form, see AR 15-6; the proponent agency is OTJAG.

IF MORE SPACE IS REQUIRED IN FILLING OUT ANY PORTION OF THIS FORM, ATTACH ADDITIONAL SHEETS

**SECTION I - APPOINTMENT**

Appointed by (b)(3), (b)(6)

(Appointing authority)

on 16 OCT 06  
(Date)

(Attach inclosure 1: Letter of appointment or summary of oral appointment data.) (See para 3-15, AR 15-6.)

**SECTION II - SESSIONS**

The (investigation) (board) commenced at \_\_\_\_\_ at \_\_\_\_\_  
(Place) (Time)

on \_\_\_\_\_ (Date) (If a formal board met for more than one session, check here . Indicate in an inclosure the time each session began and ended, the place, persons present and absent, and explanation of absences, if any.) The following persons (members, respondents, counsel) were present: (After each name, indicate capacity, e.g., President, Recorder, Member, Legal Advisor.)

The following persons (members, respondents, counsel) were absent: (Include brief explanation of each absence.) (See paras 5-2 and 5-8a, AR 15-6.)

The (investigating officer) (board) finished gathering/hearing evidence at 1600 on 22 OCT 06  
(Time) (Date)  
and completed findings and recommendations at 2000 on 24 OCT 06  
(Time) (Date)

**SECTION III - CHECKLIST FOR PROCEEDINGS**

**A. COMPLETE IN ALL CASES**

	YES	NO <sup>1/</sup>	NA <sup>2/</sup>
<b>1</b> Inclosures (para 3-15, AR 15-6)			
Are the following inclosed and numbered consecutively with Roman numerals: (Attached in order listed)			
a. The letter of appointment or a summary of oral appointment data?	<input checked="" type="checkbox"/>	<input type="checkbox"/>	<input type="checkbox"/>
b. Copy of notice to respondent, if any?(See item 9, below)	<input type="checkbox"/>	<input type="checkbox"/>	<input checked="" type="checkbox"/>
c. Other correspondence with respondent or counsel, if any?	<input type="checkbox"/>	<input type="checkbox"/>	<input checked="" type="checkbox"/>
d. All other written communications to or from the appointing authority?	<input type="checkbox"/>	<input type="checkbox"/>	<input checked="" type="checkbox"/>
e. Privacy Act Statements (Certificate, if statement provided orally)?	<input checked="" type="checkbox"/>	<input type="checkbox"/>	<input type="checkbox"/>
f. Explanation by the investigating officer or board of any unusual delays, difficulties, irregularities, or other problems encountered (e.g., absence of material witnesses)?	<input type="checkbox"/>	<input type="checkbox"/>	<input checked="" type="checkbox"/>
g. Information as to sessions of a formal board not included on page 1 of this report?	<input type="checkbox"/>	<input type="checkbox"/>	<input checked="" type="checkbox"/>
h. Any other significant papers (other than evidence) relating to administrative aspects of the investigation or board?	<input type="checkbox"/>	<input type="checkbox"/>	<input checked="" type="checkbox"/>

<sup>1/</sup> Explain all negative answers on an attached sheet.

<sup>2/</sup> Use of the N/A column constitutes a positive representation that the circumstances described in the question did not occur in this investigation or board.



		YES	NO <sup>1/</sup>	NA <sup>2/</sup>
2	Exhibits (para 3-16, AR 15-6)			
	a. Are all items offered (whether or not received) or considered as evidence individually numbered or lettered as exhibits and attached to this report?	<input checked="" type="checkbox"/>	<input type="checkbox"/>	<input type="checkbox"/>
	b. Is an index of all exhibits offered to or considered by investigating officer or board attached before the first exhibit?	<input checked="" type="checkbox"/>	<input type="checkbox"/>	<input type="checkbox"/>
	c. Has the testimony/statement of each witness been recorded verbatim or been reduced to written form and attached as an exhibit?	<input checked="" type="checkbox"/>	<input type="checkbox"/>	<input type="checkbox"/>
	d. Are copies, descriptions, or depictions (if substituted for real or documentary evidence) properly authenticated and is the location of the original evidence indicated?	<input type="checkbox"/>	<input type="checkbox"/>	<input checked="" type="checkbox"/>
	e. Are descriptions or diagrams included of locations visited by the investigating officer or board (para 3-6b, AR 15-6)?	<input type="checkbox"/>	<input type="checkbox"/>	<input checked="" type="checkbox"/>
	f. Is each written stipulation attached as an exhibit and is each oral stipulation either reduced to writing and made an exhibit or recorded in a verbatim record?	<input type="checkbox"/>	<input type="checkbox"/>	<input checked="" type="checkbox"/>
	g. If official notice of any matter was taken over the objection of a respondent or counsel, is a statement of the matter of which official notice was taken attached as an exhibit (para 3-16d, AR 15-6)?	<input type="checkbox"/>	<input type="checkbox"/>	<input checked="" type="checkbox"/>
3	Was a quorum present when the board voted on findings and recommendations (paras 4-1 and 5-2b, AR 15-6)?	<input type="checkbox"/>	<input type="checkbox"/>	<input checked="" type="checkbox"/>
<b>B. COMPLETE ONLY FOR FORMAL BOARD PROCEEDINGS (Chapter 5, AR 15-6)</b>				
4	At the initial session, did the recorder read, or determine that all participants had read, the letter of appointment (para 5-3b, AR 15-6)?	<input type="checkbox"/>	<input type="checkbox"/>	
5	Was a quorum present at every session of the board (para 5-2b, AR 15-6)?	<input type="checkbox"/>	<input type="checkbox"/>	
6	Was each absence of any member properly excused (para 5-2a, AR 15-6)?	<input type="checkbox"/>	<input type="checkbox"/>	<input type="checkbox"/>
7	Were members, witnesses, reporter, and interpreter sworn, if required (para 3-1, AR 15-6)?	<input type="checkbox"/>	<input type="checkbox"/>	<input type="checkbox"/>
8	If any members who voted on findings or recommendations were not present when the board received some evidence, does the inclosure describe how they familiarized themselves with that evidence (para 5-2d, AR 15-6)?	<input type="checkbox"/>	<input type="checkbox"/>	<input type="checkbox"/>
<b>C. COMPLETE ONLY IF RESPONDENT WAS DESIGNATED (Section II, Chapter 5, AR 15-6)</b>				
9	Notice to respondents (para 5-5, AR 15-6):			
	a. Is the method and date of delivery to the respondent indicated on each letter of notification?	<input type="checkbox"/>	<input type="checkbox"/>	
	b. Was the date of delivery at least five working days prior to the first session of the board?	<input type="checkbox"/>	<input type="checkbox"/>	
	c. Does each letter of notification indicate —			
	(1) the date, hour, and place of the first session of the board concerning that respondent?	<input type="checkbox"/>	<input type="checkbox"/>	
	(2) the matter to be investigated, including specific allegations against the respondent, if any?	<input type="checkbox"/>	<input type="checkbox"/>	
	(3) the respondent's rights with regard to counsel?	<input type="checkbox"/>	<input type="checkbox"/>	
	(4) the name and address of each witness expected to be called by the recorder?	<input type="checkbox"/>	<input type="checkbox"/>	
	(5) the respondent's rights to be present, present evidence, and call witnesses?	<input type="checkbox"/>	<input type="checkbox"/>	
	d. Was the respondent provided a copy of all unclassified documents in the case file?	<input type="checkbox"/>	<input type="checkbox"/>	
	e. If there were relevant classified materials, were the respondent and his counsel given access and an opportunity to examine them?	<input type="checkbox"/>	<input type="checkbox"/>	<input type="checkbox"/>
10	If any respondent was designated after the proceedings began (or otherwise was absent during part of the proceedings):			
	a. Was he properly notified (para 5-5, AR 15-6)?	<input type="checkbox"/>	<input type="checkbox"/>	<input type="checkbox"/>
	b. Was record of proceedings and evidence received in his absence made available for examination by him and his counsel (para 5-4c, AR 15-6)?	<input type="checkbox"/>	<input type="checkbox"/>	<input type="checkbox"/>
11	Counsel (para 5-6, AR 15-6):			
	a. Was each respondent represented by counsel?	<input type="checkbox"/>	<input type="checkbox"/>	
	Name and business address of counsel:			
	(If counsel is a lawyer, check here <input type="checkbox"/> )			
	b. Was respondent's counsel present at all open sessions of the board relating to that respondent?	<input type="checkbox"/>	<input type="checkbox"/>	<input type="checkbox"/>
	c. If military counsel was requested but not made available, is a copy (or, if oral, a summary) of the request and the action taken on it included in the report (para 5-6b, AR 15-6)?	<input type="checkbox"/>	<input type="checkbox"/>	<input type="checkbox"/>
12	If the respondent challenged the legal advisor or any voting member for lack of impartiality (para 5-7, AR 15-6):			
	a. Was the challenge properly denied and by the appropriate officer?	<input type="checkbox"/>	<input type="checkbox"/>	<input type="checkbox"/>
	b. Did each member successfully challenged cease to participate in the proceedings?	<input type="checkbox"/>	<input type="checkbox"/>	<input type="checkbox"/>
13	Was the respondent given an opportunity to (para 5-8a, AR 15-6):			
	a. Be present with his counsel at all open sessions of the board which deal with any matter which concerns that respondent?	<input type="checkbox"/>	<input type="checkbox"/>	
	b. Examine and object to the introduction of real and documentary evidence, including written statements?	<input type="checkbox"/>	<input type="checkbox"/>	<input type="checkbox"/>
	c. Object to the testimony of witnesses and cross-examine witnesses other than his own?	<input type="checkbox"/>	<input type="checkbox"/>	<input type="checkbox"/>
	d. Call witnesses and otherwise introduce evidence?	<input type="checkbox"/>	<input type="checkbox"/>	
	e. Testify as a witness?	<input type="checkbox"/>	<input type="checkbox"/>	
	f. Make or have his counsel make a final statement or argument (para 5-9, AR 15-6)?	<input type="checkbox"/>	<input type="checkbox"/>	
14	If requested, did the recorder assist the respondent in obtaining evidence in possession of the Government and in arranging for the presence of witnesses (para 5-8b, AR 15-6)?	<input type="checkbox"/>	<input type="checkbox"/>	<input type="checkbox"/>
15	Are all of the respondent's requests and objections which were denied indicated in the report of proceedings or in an inclosure or exhibit to it (para 5-11, AR 15-6)?	<input type="checkbox"/>	<input type="checkbox"/>	<input type="checkbox"/>
<b>FOOTNOTES:</b> 1/ Explain all negative answers on an attached sheet. 2/ Use of the N/A column constitutes a positive representation that the circumstances described in the question did not occur in this investigation or board.				

**SECTION IV - FINDINGS** (para 3-10, AR 15-6)

The (investigating officer) (board) , having carefully considered the evidence, finds:

See attached Memorandum, under date 24 OCT 06.

**SECTION V - RECOMMENDATIONS** (para 3-11, AR 15-6)

In view of the above findings, the (investigating officer) (board) recommends:

See attached Memorandum, under date 24 OCT 06.

SECTION VI - AUTHENTICATION (para 3-17, AR 15-6)

THIS REPORT OF PROCEEDINGS IS COMPLETE AND ACCURATE. (If any voting member or the recorder fails to sign here or in Section VII below, indicate the reason in the space where his signature should appear.)

(b)(3), (b)(6)

\_\_\_\_\_  
(Recorder)

\_\_\_\_\_  
(Investigating Officer) (President)

\_\_\_\_\_  
(Member)

\_\_\_\_\_  
(Member)

\_\_\_\_\_  
(Member)

\_\_\_\_\_  
(Member)

SECTION VII - MINORITY REPORT (para 3-13, AR 15-6)

To the extent indicated in Inclosure \_\_\_\_\_, the undersigned do(es) not concur in the findings and recommendations of the board. (In the inclosure, identify by number each finding and/or recommendation in which the dissenting member(s) do(es) not concur. State the reasons for disagreement. Additional/substitute findings and/or recommendations may be included in the inclosure.)

\_\_\_\_\_  
(Member)

\_\_\_\_\_  
(Member)

(b)(5), (b)(3), (b)(6)

(b)(3), (b)(6)



REPLY TO  
ATTENTION OF

DEPARTMENT OF THE ARMY  
89th Military Police Brigade  
Camp Victory, Iraq APO AE 09342

AFVP-CDR

16 October 2006

MEMORANDUM FOR (b)(3), (b)(6) 372d Military Police Battalion, APO AE 09342

SUBJECT: Appointment as Investigating Officer

1. You are appointed an investigating officer pursuant to AR 15-6, para. 2-1(a)(3) to investigate the facts and circumstances surrounding the KIA of a Soldier belonging to 57th Military Police Company on 13 October 2006. This is your primary duty and takes precedence over all other assigned duties until completed.

2. Upon receipt of this order, IAW AR 15-6 you shall consult with your legal advisor (b)(3), (b)(6) (b)(3), (b)(6) at (b)(3), (b)(6) or (b)(3), (b)(6) to develop an investigation plan and obtain forms and regulations.

3. In addition to determining the facts and circumstances of this incident, your investigation shall specifically determine:

- a. Were standard operation procedures used during the incident?
- b. Were appropriate safeguards in place to prevent the incident?

4. When conducting your investigation, follow the informal procedures outlined in AR 15-6. Record and swear all witness statements on DA Form 2823. Provide each witness a Privacy Act statement. Prior to questioning any person whom you suspect has violated the any law, you must advise that person of his or her rights under Article 31, UCMJ, using DA Form 3881. Consult with legal counsel before any rights advisement.

5. Make specific findings and recommendations to assist me in determining the proper disposition of these allegations. Cite the statements that support your findings. State who you believe and why, if there is conflicting evidence. Provide an index and tab one copy for your report. Submit your report on DA Form 1574 to me within five days of receipt of this appointment. Extensions must be requested in writing from me and state the reason for delays

Encl  
as

(b)(3), (b)(6)

I

CERTIFICATE OF DEATH (RIPAS)

DRAFT

NAME OF DECEASED (Last, First, Middle) <i>BTB: STANTON, KENNY, F</i>		GRADE <i>E-3</i>	BRANCH OF SERVICE <i>ARMY</i>	SOCIAL SECURITY NUMBER <i>(b)(3), (b)(6)</i>
ORGANIZATION <i>57<sup>th</sup> MP CO.</i>		NATION (e.g., United States) <i>US</i>	DATE OF BIRTH <i>2 SEP 86</i>	<input checked="" type="checkbox"/> MALE Masculin <input type="checkbox"/> FEMALE Féminin
RACE <i>CAUCASOID</i>	MARITAL STATUS <i>SINGLE</i>		RELIGION <i>PROTESTANT</i>	OTHER (Specify)
<i>NEGRUID</i>	<i>MARRIED</i>	<i>DIVORCED</i>	<i>(b)(3), (b)(6)</i>	
<i>OTHER (Specify)</i>	<i>WIDOWED</i>	<i>SEPARATED</i>	<i>JEVISH</i>	
NAME OF NEXT OF KIN		RELATIONSHIP TO DECEASED		
STREET ADDRESS		CITY OF TOWN AND STATE (include ZIP Code)		

MEDICAL STATEMENT Declaration médicale

CAUSE OF DEATH (Enter only one cause per line) <i>Explosive Trauma</i>		INTERVAL BETWEEN ONSET AND DEATH <i>immediate</i>
DISEASE OR CONDITION DIRECTLY LEADING TO DEATH <i>Maladie ou condition directement responsable de la mort</i>		
ANTECEDENT CAUSES <i>Symptômes précurseurs de la mort</i>	MORBID CONDITION, IF ANY, LEADING TO PRIMARY CAUSE <i>Condition morbide, s'il y a lieu, menant à la cause primaire</i>	
	UNDERLYING CAUSE, IF ANY, GIVING RISE TO PRIMARY CAUSE <i>Raison fondamentale, s'il y a lieu, ayant suscité la cause primaire</i>	
OTHER SIGNIFICANT CONDITIONS <i>Autres conditions significatives</i>		

MODE OF DEATH <input checked="" type="checkbox"/> NATURAL <input type="checkbox"/> ACCIDENT <input type="checkbox"/> SUICIDE <input checked="" type="checkbox"/> HOMICIDE	AUTOPSY PERFORMED <input type="checkbox"/> YES <input checked="" type="checkbox"/> NO	CIRCUMSTANCES SURROUNDING DEATH DUE TO EXTERNAL CAUSES <i>Improvised Explosive Device</i>
NAME OF PATHOLOGIST		AVIATION ACCIDENT <input type="checkbox"/> YES <input type="checkbox"/> NO
SIGNATURE		DATE

DATE OF DEATH *evening 13 Oct 2006* PLACE OF DEATH *Baghdad, Iraq*

I HAVE VIEWED THE REMAINS OF THE DECEASED AND DEATH OCCURRED AT THE TIME INDICATED AND FROM THE CAUSES AS STATED ABOVE.

NAME	TITLE OR DEGREE <i>M.D.</i>
STATION OR ADDRESS <i>417 EMBASSY CLUB B, Baghdad Int'l Airport</i>	
DATE <i>14 Oct 2006</i>	SIGNATURE <i>(b)(3), (b)(6)</i>

DRAFT

III

MEDICAL RECORD

CHRONOLOGICAL RECORD OF MEDICAL CARE

DATE	SYMPTOMS, DIAGNOSIS, TREATMENT, TREATING ORGANIZATION <i>(Sign each entry)</i>
14 Oct 06	Death Note
0300	<p>PFC Kenny Stanton is a 20 year-old male who was killed on 13 Oct 2006 when his vehicle struck an improvised explosive device in Baghdad, Iraq. His most notable injuries include severe fracture of mandible and massive wound to upper neck. Mandible is missing. Compound fracture of right leg (below knee) is also apparent. Death most certainly occurred instantly from his facial and neck wounds.</p>
	<p>(b)(3), (b)(6)</p>

HOSPITAL OR MEDICAL FACILITY	STATUS	DEPART./SERVICE	RECORDS MAINTAINED AT
SPONSOR'S NAME	SSN/ID NO.	RELATIONSHIP TO SPONSOR	
PATIENT'S IDENTIFICATION: <i>(For typed or written entries, give: Name - last, first, middle; ID No or SSN; Sex; Date of Birth; Rank/Grade.)</i>		REGISTER NO.	WARD NO.

STANTON, KENNY, F

(b)(3), (b)(6)

CHRONOLOGICAL RECORD OF MEDICAL CARE  
 Medical Record  
 STANDARD FORM 600 (REV. 6-97)  
 Prescribed by GSA/ICMR  
 FIRM (41 CFR) 201-9.202-1 USAPA V2.00

RECORD OF IDENTIFICATION PROCESSING  
ANATOMICAL CHART

LAST NAME - FIRST NAME - MIDDLE INITIAL (for unknown number) <b>BTB: STANTON, KENNY, F</b>			GRADE <b>E-3</b>		(b)(3), (b)(6)	
NAME OF CEMETERY, EVACUATION NUMBER, OR SEARCH AND RECOVERY NO. <b>410-06/JAR III<sup>th</sup> Inf Co. 104</b>			PLOT <b>NIA</b>	ROW <b>NIA</b>	GRAVE <b>NIA</b>	AGE (Yrs) <b>20</b>
					HEIGHT <b>69"</b>	

BLACK OUT PORTIONS NOT RECOVERED

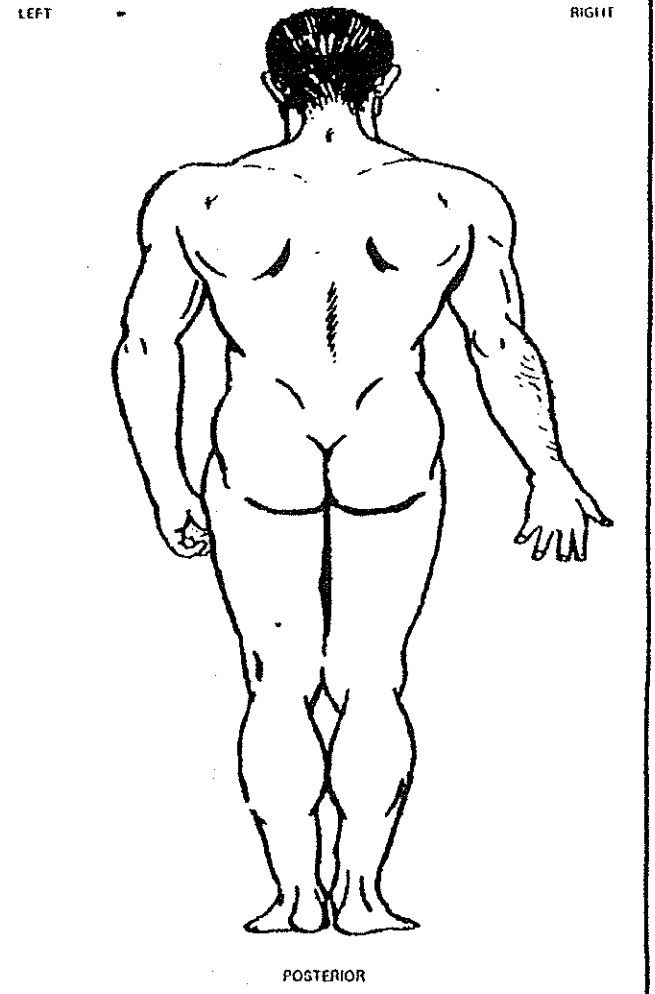
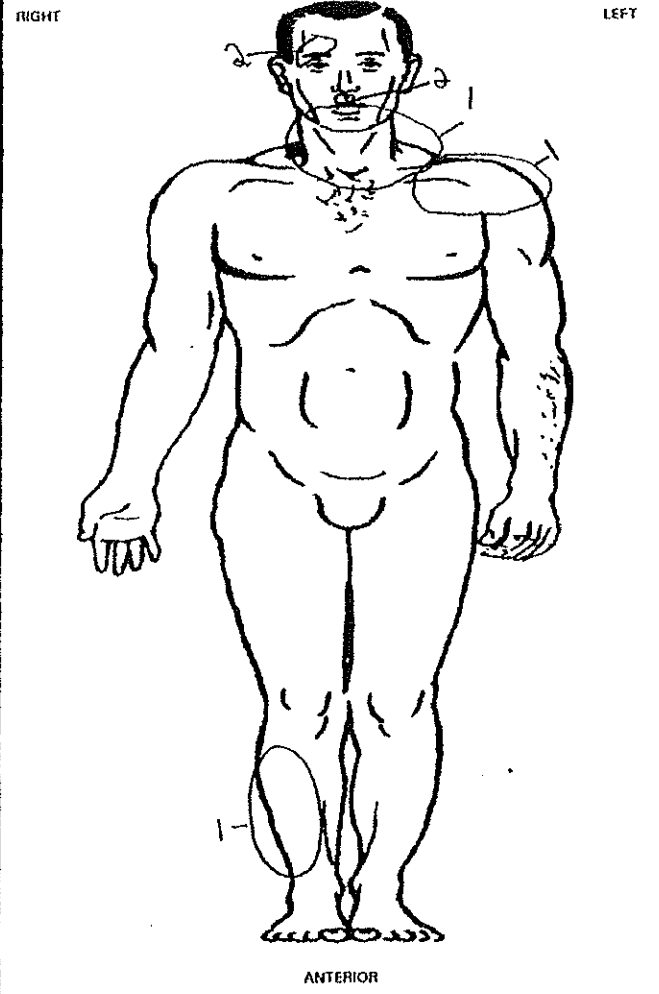

CONDITION OF REMAINS (Check pertinent blocks)

<input type="checkbox"/> SEMI-SKELETAL	<input checked="" type="checkbox"/> FLESH COVERED	<input type="checkbox"/> INTACT	<input type="checkbox"/> DECOMPOSED
		<input type="checkbox"/> BURNED 1 Degree: <input type="checkbox"/> 1st <input type="checkbox"/> 2d <input type="checkbox"/> 3d	

REMARKS (Continue on reverse if additional space is required)

1- OPEN WOUNDS  
2- LACERATIONS

NAME

(b)(3), (b)(6)

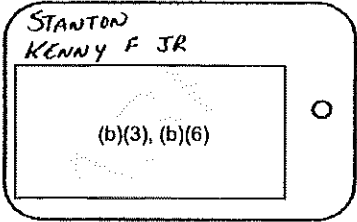
RECORD OF IDENTIFICATION PROCESSING <i>(Effects and Physical Data)</i>			DATE
LAST NAME - FIRST NAME - MIDDLE INITIAL (Or unknown number) <i>BTB: STANTON, KENNY, F</i>	GRADE <i>E-3</i>	SERVICE NO. SSAN <i>(b)(3), (b)(6)</i>	CIL CASE NUMBER (If applicable) <i>N/A</i>
NAME OF CEMETERY, EVACUATION NUMBER, OR SEARCH AND REC <i>410-06/AR III<sup>rd</sup> In CO. 104</i>		PLOT <i>N/A</i>	ROW <i>N/A</i>
RECEIVED FROM <i>FOB JUSTICE</i>		GRAVE <i>N/A</i>	
OFFICIAL IDENTIFICATION FOUND WITH REMAINS (Include personal effects aiding identification) <i>1 EA GENEVA CONVENTIONS ID CARD INSC. "STANTON, KENNY" 2 EA ID TAGS (w) CHAIN / NOTHING Follows /</i>		IMPRINT OF IDENTIFICATION TAG 	
ITEMS OF CLOTHING AND EQUIPMENT FOUND WITH REMAINS (Indicate type, color, size, markings, service, etc. If laundry marks are indistinct, follow procedures outlined in TM 10-286)			
<i>1 EA TOP (ACU) 1 EA T-SHIRT BROWN IN COLOR 1 EA BOTTOM (ACU) 1 PR BOOTS TAN IN COLOR 1 EA BELT TAN IN COLOR 1 EA Unit PATCH (ACU) 1 EA PATCH US FLAG (w) VELCRO 1 EA NAME TAPE INSC. "US ARMY" (ACU)</i>		<i>1 EA NAME TAPE INSC. "STANTON" (ACU) 1 EA RANK PFC (ACU) 1 PR SOCKS green IN COLOR / NOTHING Follows /</i>	
FINGERPRINTS TAKEN <input type="checkbox"/> YES <input checked="" type="checkbox"/> NO	X-RAYS MADE <input type="checkbox"/> YES <input checked="" type="checkbox"/> NO	FLUOROSCOPE STATEMENT ATTACHED <input type="checkbox"/> YES <input checked="" type="checkbox"/> NO	
PHOTOGRAPHS TAKEN <input type="checkbox"/> YES <input checked="" type="checkbox"/> NO	ANTHROPOLOGICAL STATEMENT MADE <input type="checkbox"/> YES <input checked="" type="checkbox"/> NO	CHEMICAL STATEMENT ATTACHED <input type="checkbox"/> YES <input checked="" type="checkbox"/> NO	
PHYSICAL DESCRIPTION			
ESTIMATED HEIGHT <i>69"</i>	MUSCULARITY <i>MEDIUM</i>	COLOR OF HAIR <i>BLACK</i>	RACE OR NATIVITY <i>MONGOLOID</i>
TATTOOS, SCARS OR MARKS ON BODY <i>SEE DD Form 893</i>			
EVIDENCE OF HEALED FRACTURES AND BONE MALFORMATIONS <i>SEE DD Form 893</i>			
WOUNDS OR INJURIES <i>SEE DD Form 893</i>			
I HAVE PERSONALLY VIEWED THE REMAINS OF THIS DECEASED AND ALL RESULTING INFORMATION HAS BEEN RECORDED TO THE BEST OF MY KNOWLEDGE.			
SIGNATURE <i>(b)(3), (b)(6)</i>		DATE	



STATEMENT OF RECOGNITION OF DECEASED

PRIVACY ACT STATEMENT

AUTHORITY: 10 USC Sections 1481 through 1488, EO 9397, Nov. 1943 (SSN).

PURPOSE AND USE: This form is used to establish initial identification of deceased personnel.

DISCLOSURE: Personal information provided on this form is given on a voluntary basis. Failure to provide this information, however, may result in improper identification of the deceased person and person making visual identification.

1. TENTATIVELY IDENTIFIED DECEDENT

a. NAME (Last, First, Middle Initial) for Unidentified) Stanton, kenny F		b. RANK E-3	c. (b)(3), (b)(6)
d. ORGANIZATION 57th MP Co		e. SERVICE Active Duty Army	

2. I HAVE PERSONALLY VIEWED THE REMAINS TENTATIVELY IDENTIFIED ABOVE. RECOGNITION IS BASED ON THE FOLLOWING.

a. SEX MALE	b. APPROXIMATE AGE (Years) 22	c. APPROXIMATE HEIGHT 5' 10"	d. RACE Hispanic
e. HAIR COLOR (If brown, indicate light or dark, as applicable) DARK BROWN		f. BUILD/MUSCULARITY (Slender, medium, heavy or obese) Slender - Medium	

g. IDENTIFYING MARKS (Fully describe by type and location ALL known scars, tattoos, birthmarks, amputations or other body markings to support the identification.)

h. REMARKS

3. DETAILS OF VIEWING

a. DATE (YYYYMMDD) 20061014	b. TIME 0114	c. PLACE BIAP Mortuary
--------------------------------	-----------------	---------------------------

4. PERSON MAKING VISUAL IDENTIFICATION

a. (b)(3), (b)(6)		
d. 57 MP Co	(b)(3), (b)(6)	f. DATE SIGNED (YYYYMMDD) 20061014
g. RELATIONSHIP TO DECEASED (CDR, ISG, Friend, Relative, etc.) Friend	h. LENGTH OF TIME YOU KNEW DECEASED (Number of months or years) 8 MONTHS	

5. WITNESS

I certify that the individual identified in Item 4 has viewed the remains in my presence, and that to the best of my knowledge and belief the above statements are true.

(b)(3), (b)(6)
----------------

**MILITARY OPERATIONS  
RECORD OF PERSONAL EFFECTS OF DECEASED PERSONNEL**

1. DATE (YYYYMMDD) *20061014* 2. PAGE *1*  
OF *1* PAGES

**PRIVACY ACT STATEMENT**  
AUTHORITY: 10 USC Sections 1481 through 1488, EO 9397, Nov. 1943 (SSN).

**PURPOSE AND USE:** This form is used to establish initial identification of deceased personnel.

**DISCLOSURE:** Personal information provided on this form is given on a voluntary basis. Failure to provide this information, however, may result in improper identification of the deceased person and person making visual identification.

**3. TENTATIVELY IDENTIFIED DECEDENT**

a. NAME (Last, First, Middle Initial) (or Unidentified)	b. GRADE	c. SSN	d. ORGANIZATION	e. STATUS	f. DATE OF STATUS (YYYYMMDD)
<i>BIB: STANTON, KENNY, F</i>	<i>E-3</i>	<i>(b)(3), (b)(6)</i>	<i>57<sup>th</sup> MP Co.</i>	<i>DECEASED</i>	<i>20061013</i>

4. PLACE OF RECOVERY (Include grid coordinates)	5. DATE OF RECOVERY (YYYYMMDD)	6. EVACUATION NUMBERS
<i>FOB JUSTICE</i>	<i>20061014</i>	a. #1 <i>410-06/AR 11<sup>th</sup> Inf Co/04</i> b. #2

**7. INVENTORY OF EFFECTS**

a. QUANTITY	b. DESCRIPTION	c. RECEIVED	d. CONDITION	e. DISPOSITION
<i>2EA</i>	<i>MISC. PAPERS</i>		<i>FAIR</i>	
<i>2EA</i>	<i>MISC. KEYS INSC. "GRAY IN COLOR FORGIVENESS, REG"</i>		<i>FAIR</i>	
<i>/</i>	<i>NOTHING Follows</i>			<i>/</i>

**8. FUNDS/NEGOTIABLE INSTRUMENTS/OTHER HIGH VALUE ITEMS TRANSMITTED WITH EFFECTS**

a. QUANTITY	b. DESCRIPTION	c. RECEIVED	d. CONDITION	e. DISPOSITION
<i>/</i>	<i>NOTHING Follows</i>			<i>/</i>

**9. EFFECTS INVENTORIED ABOVE REPRESENT (X as appropriate)**

ALL KNOWN EFFECTS  ALL KNOWN EFFECTS RECOVERED FROM UNIT  ALL KNOWN EFFECTS RECOVERED FROM REMAINS

10. ORGANIZATION	<i>(b)(3), (b)(6)</i>	c. ORGANIZATION	e. DATE SIGNED (YYYYMMDD)
		<i>111<sup>th</sup> Inf Co. (MA)</i>	<i>20061014</i>

a. NAME (Last, First, Middle Initial)	b. GRADE	c. ORGANIZATION	e. DATE SIGNED (YYYYMMDD)
d. SIGNATURE			e. DATE SIGNED (YYYYMMDD)

**12. RECEIVING OFFICIAL**

a. NAME (Last, First, Middle Initial)	b. GRADE	c. ORGANIZATION	e. DATE SIGNED (YYYYMMDD)
d. SIGNATURE			e. DATE SIGNED (YYYYMMDD)



CSH/MACP/TMEP  
IBA AND KEVLAR TRACKING CHART



NAME	EVAC #	OSN	UNIT	DATE	RANK	KEVLAR YR	IBA YR	REMARKS
BUS STANTON, KENNETH E	140-06/ANM#80008	(b)(3), (b)(6)	57th MP Bn	2006/10/14	Pfc	110	200	
COMMANDER, 1SG OR OTHER POC								
NAME, GRADE, ORGANIZATION AND DATE								SIGNATURE

JMAO-AFMIE 111-05  
REV NOV 05

THIS FORM WILL ACCOMPANY REMAINS THROUGH OUT MOVEMENT PROCESS WITH CSH, MACP, TMEP, AND DOVER RECEIVING THE FORM. THIS FORM WILL INITIALLY BE FILLED OUT BY GAINING LOCATION FOR THE REMAIN AND FOWARDED WITH PAPER WORK AND REMAIN THROUGH CHANNELS. A COPY WILL BE FAXED FROM THE TMEP TO THE TMAO WITH NORMAL PAPER WORK. THE FORM SHOULD HAVE TWO POC CONTACTS IF AT ALL POSSIBLE WITH GOOD CONTACT INFORMATION. THIS FORM WILL HELP IN TRACKING DOWN KEVLAR AND IBA FOR SOLDIERS NOT RECEIVED EVEN IF SHIPPED LATER.

CJTF7 CASUALTY REPORT FORM

(01) Report Type: SUPP (Supplemental report)

(02) Casualty Type: HOSTILE

(03) Casualty Status: DECEASED

(04) Report Number: 4

(05) Previous Casualty Stat.: N/A

(06) Init Report #: 3

(07) Category: Military

(08) SSN: (b)(3), (b)(6)

(09) NAME (LAST, FIRST MI): STANTON JR, KENNY

(10) Race: White

(11) Birth Date/Place: 27 SEP 86/HEMET, CA

(12) Rank: PFC

(13) Branch of Service/Component: Army

(14) Unit, Bn, Bde, Div/MSC: 57TH MP CO, 372ND MP BN, 89TH MP BDE, V CORPS

(15) PMOS\_ENLD: 31B

(16 -23) Not Applicable. NA

(24) Died In/Out of Med Treat Facility: DIED OUT OF MED TREAT FACILITY

(25) Home of Record City,State/Country: HEMET, CA/USA

(26 - 30) Not Applicable. NA

(31) Vehicular Involvement: Yes

(32) Vehicle Type (if up armored vehicle please state): M1114/Up Armored

(33) Vehicle Owner: US GOVERNMENT

(34) Position in Vehicle: DRIVER

(35) Duty Status/Date of Duty Status: PDY/20061013

(36) Incident Date/Time: 10/13/06 /2057

(37) Incident location, Nearest Iraq City: BAGHDAD, IRAQ - MB3324592075

(38) Activity: While Element 1-2D was conducting a patrol near Creek Road and Route Expos when an IED hit their vehicle on the north side of the road causing disabling damage to vehicle. PFC Stanton, the driver, was killed from wounds resulting from upper body and head injuries.

(39) Circumstances: Damage to the driver side door prevented PFC Stanton's remains from being removed from the vehicle. The truck was inoperable and was towed to FOB Justice. Remains will be flown to BIAP mortuary affairs.

(40) Inflicting Force: Enemy forces

(41) Diagnosis: N/A

IV

CJTF7 CASUALTY REPORT FORM

(42) Hospital Name, Iraq City, Iraq: N/A

(43) Not Applicable. NA

(44) Prognosis: KIA

(45 - 46) Not Applicable. NA

(47) Religion: (b)(3), (b)(6)

(48) Received Religious Ministrations: NA

(49) Not Applicable. NA

(50) Training Related: NA

(51) Date Recommended/Selected for Promotion: Recommended for Promotion for November 2006.

(52) Rank to which Recommended: SPC

(53) Higher Rank Held: PFC

(54 - 55) Not Applicable. NA

(56) Investigation Required: Yes/15-6

(57) Date of Death/Time of Death: 13 Oct 06/2110

(58) Hospital Died in/Iraq City/Iraq: N/A

(59) Cause of Death: IED

(60) Additional Remarks/Name and Telephone # of Reporter: (b)(3), (b)(6)

Equipment Worn: IBA with front/back SAPI, throat guard, neck guard, groin guard and DAPS; Advanced Combat Helmet; Ballistic Eye Protection; CBT Hearing Protection; Nomex Gloves, Vehicle M1114\*

(61) Remarks

15-6 INVESTIGATION
COMMAND REQUESTS SSI-FWTS
SCMO NAME FOR PE
CERTIFIER'S NAME
DATE TIME GROUP OF INVENTORY
DATE TIME GROUP DELIVERED TO
MACP

Pages 22 through 25 redacted for the following reasons:

-----  
(b)(3), (b)(6)  
(b)(6), (b)(3)

UNCLASSIFIED

Privacy Act Statement  
(5 U.S.C. 522a)

AUTHORITY: 5 U.S.C.D. 301 and 10 U.S.C. 3012

PURPOSE: The purpose for collecting this information is to obtain facts and make recommendations to assist the appropriate authorities in determining what action to take with regard to: IED STRIKE ON

13 OCT 06 AT APPROX. 2057 RESULTING IN STANTON KIA

ROUTINE USES: Any information you provide is disclosable to members of the Department of Defense who have a need for the information in performance of their official duties, and where use of such information is compatible with the purpose for which the information is collected. In addition, the information may be disclosed to Government agencies and persons outside the Department of Defense for law enforcement purposes, or if determined to be disclosable pursuant to a request submitted under the Freedom of Information Act, or if needed for Congressional or other Government Investigations.

DISCLOSURE MANDATORY FOR INDIVIDUAL WHO MAY BE ORDERED TO TESTIFY: Providing the information is mandatory. Failure to provide information could result in disciplinary or other adverse action against you under the UCMJ or applicable Army or other federal regulations.

DISCLOSURE VOLUNTARY FOR INDIVIDUAL WARNED OF HIS RIGHTS UNDER ARTICLE 31, UCMJ, OR THE FIFTH AENDMENT OF THE U.S. CONSTITUTION: Providing the information is voluntary. There will be no adverse effect on you for not furnishing the information other than essential information that might not otherwise be available to the commander for his decision(s) in this matter.

ACKNOWLEDGMENT

The Privacy Act Statement above has been read to me and a copy of it has been provided to me. I understand its contents.

21 OCT 06  
Date

\_\_\_\_\_  
(b)(3), (b)(6)  
Signature

\_\_\_\_\_  
(b)(3), (b)(6)  
Printed Name and Rank

**V**

SWORN STATEMENT

For use of this form, see AR 190-45; the proponent agency is PMG.

PRIVACY ACT STATEMENT

AUTHORITY: Title 10 USC Section 301; Title 5 USC Section 2951; E.O. 9397 dated November 22, 1943 (SSN).
PRINCIPAL PURPOSE: To provide commanders and law enforcement officials with means by which information may be accurately identified.
ROUTINE USES: Your social security number is used as an additional/alternate means of identification to facilitate filing and retrieval.
DISCLOSURE: Disclosure of your social security number is voluntary.

1. LOCATION: CAMP VICTORY, IRAQ
3. TIME: 0845
1. FILE NUMBER: (b)(3), (b)(6)

(b)(3), (b)(6)

8. ORGANIZATION OR ADDRESS: 57th MP CO

(b)(3), (b)(6)

... WANT TO MAKE THE FOLLOWING STATEMENT UNDER OATH:

On 13 Oct 06 while on patrol in the Shula area on Creek we were attacked by unknown person(s) at Grid MB324592075 at approximately 2057. I was looking to the front of the vehicle from the turret looking for a black BMW when I heard a loud boom and felt the concussion vibrate the entire vehicle. My (b)(3), (b)(6) yelled out that we were getting attacked and to get out of the kill zone. I drop down to let (b)(3), (b)(6) know that I was alright. A few seconds later we turn around to go back after we realized only one truck was with us. I was told to look to see if I could see the other trucks. That is when (b)(3), (b)(6) said (b)(3), (b)(6) truck was hit. I was told to keep alert and start pulling security. (b)(3), (b)(6) was enroute to our location upon going to the scene I saw (b)(3), (b)(6) on the ground, at that time (b)(3), (b)(6) and (b)(3), (b)(6) were on scene too. (b)(3), (b)(6) was running up to treat (b)(3), (b)(6) my truck was backing up to tow 153 to FOB Justice (b)(3), (b)(6) and his squad took the wounded to the CASH. Everyone had all there protective gear on and the (b)(1)1.4a was on so was the (b)(1)1.4a. All TTP's were followed All reports were sent up to the TOC. We found out that somebody set off an EFP at us hitting the third vehicle. The M114 was heavily damaged with 1 KIA (Stanton) and 2 WIA (b)(3), (b)(6)

10. EXHIBIT

11. INITIALS: (b)(3), (b)(6) ON MAKING STATEMENT

PAGE 1 OF 1 PAGES

ADDITIONAL PAGES MUST CONTAIN THE HEADING "STATEMENT OF ... TAKEN AT ... DATED ..."

THE BOTTOM OF EACH ADDITIONAL PAGE MUST BEAR THE INITIALS OF THE PERSON MADE AND MUST BE INDICATED.

XIV



ORGANIZATION OR ADDRESS

ORGANIZATION OR ADDRESS

(Authority To Administer Oaths)

Article 136(b)(4), UCMJ  
(Typed Name of Person Administering Oath)

(b)(3), (b)(6)

Oath)

(b)(3), (b)(6)

at C

administer oaths, this 21st day of October 2006  
Subscribed and sworn to before me, a person authorized by law to

WITNESSES:

(ant)

(b)(3), (b)(6)

HAVE READ OR HAVE HAD READ TO ME THIS STATEMENT  
WHICH I FULLY UNDERSTAND THE CONTENTS OF THE ENTIRE STATEMENT MADE  
BY ME. THE STATEMENT IS TRUE. I HAVE INITIALED ALL CORRECTIONS AND HAVE INITIALED THE BOTTOM OF EACH PAGE  
CONTAINING THE STATEMENT. I HAVE MADE THIS STATEMENT FREELY WITHOUT HOPE OF BENEFIT OR REWARD, WITHOUT  
THREAT OF PUNISHMENT, AND WITHOUT COERCION, UNLAWFUL INFLUENCE, OR UNLAWFUL INDUCEMENT.

AFFIDAVIT

(b)(3), (b)(6)

9. STATEMENT (Continued)

STATEMENT OF

TAKEN AT

DATED

Privacy Act Statement  
(5 U.S.C. 522a)

AUTHORITY: 5 U.S.C.D. 301 and 10 U.S.C. 3012

PURPOSE: The purpose for collecting this information is to obtain facts and make recommendations to assist the appropriate authorities in determining what action to take with regard to: TED Strike on

13 Oct 06 at approx 2057 resulting in Stanton  
KIA

ROUTINE USES: Any information you provide is disclosable to members of the Department of Defense who have a need for the information in performance of their official duties, and where use of such information is compatible with the purpose for which the information is collected. In addition, the information may be disclosed to Government agencies and persons outside the Department of Defense for law enforcement purposes, or if determined to be disclosable pursuant to a request submitted under the Freedom of Information Act, or if needed for Congressional or other Government Investigations.

DISCLOSURE MANDATORY FOR INDIVIDUAL WHO MAY BE ORDERED TO TESTIFY: Providing the information is mandatory. Failure to provide information could result in disciplinary or other adverse action against you under the UCMJ or applicable Army or other federal regulations.

DISCLOSURE VOLUNTARY FOR INDIVIDUAL WARNED OF HIS RIGHTS UNDER ARTICLE 31, UCMJ, OR THE FIFTH AENDMENT OF THE U.S. CONSTITUTION: Providing the information is voluntary. There will be no adverse effect on you for not furnishing the information other than essential information that might not otherwise be available to the commander for his decision(s) in this matter.

ACKNOWLEDGMENT

The Privacy Act Statement above has been read to me and a copy of it has been provided to me. I understand its contents.

10/21/2006  
Date

(b)(3), (b)(6)

XIII

SWORN STATEMENT

For use of this form, see AR 190-45; the proponent agency is PMG.

PRIVACY ACT STATEMENT

AUTHORITY: Title 10 USC Section 301; Title 5 USC Section 2951; E.O. 9397 dated November 22, 1943 (SSN).
PRINCIPAL PURPOSE: To provide commanders and law enforcement officials with means by which information may be accurately identified.
ROUTINE USES: Your social security number is used as an additional/alternate means of identification to facilitate filing and retrieval.
DISCLOSURE: Disclosure of your social security number is voluntary.

1. LOCATION: Cp Liberty, Iraq
2. DATE (YYYYMMDD): 2006 10 22
3. TIME: 0811
4. FILE NUMBER:

(b)(3), (b)(6)

57th Military Police Company

9. I, (b)(3), (b)(6), WANT TO MAKE THE FOLLOWING STATEMENT UNDER OATH:

THIS STATEMENT IS INTENDED TO CLARIFY AND INVESTIGATE THE EVENTS OF 13 OCT 06.

On October, 13, 2006 Second squad was short of Personnel and my team 1-3B went with second squad to a patrol mission on the Shifa area. We were driving on expos and we saw an IP vehicle escorting a black BMW and we tried to stop them but they turned off their lights and we lost them. We took a left and then we were on shit creek Road the truck in front of me got hit with an IED then I saw (b)(3), (b)(6) on the floor and I knew that they needed help so I got out of the vehicle and tried to help Pfc Stanton I got (b)(3), (b)(6) and went to the Driver side. And I saw that the Drivers window was missing so I grabbed Stanton from his belt and said Stanton get up and it was dark so I couldn't see the damage and Stanton didn't respond. That is when I went to the Rear Right Door and I got in the vehicle and (b)(3), (b)(6) gave me his flashlight and I saw that there was nothing I (b)(3), (b)(6) could do to help Stanton. I got out and (b)(3), (b)(6) the medic asked me to help him carry (b)(3), (b)(6) to one of first squad vehicle so I did then I saw a vehicle that was not stopping and was getting close to our Area so I shot a warning shot. Then after that (b)(3), (b)(6) we towed the vehicle to Camp Justice.

/// END of statement ///

10. EXHIBIT: 11. INITIALS: (b)(3), (b)(6) IN MAKING STATEMENT PAGE 1 OF 2 PAGES

ADDITIONAL PAGES MUST CONTAIN THE HEADING "STATEMENT TAKEN AT \_\_\_\_\_ DATED \_\_\_\_\_"

THE BOTTOM OF EACH ADDITIONAL PAGE MUST BEAR THE INITIALS OF THE PERSON MAKING STATEMENT AND MUST BE INDICATED.

XII

STATEMENT OF (b)(3), (b)(6) TAKEN AT 2811 DATED 22 oct 06

9. STATEMENT (Continued)

END of Statement  
not used

AFFIDAVIT

I, (b)(3), (b)(6), HAVE READ OR HAVE HAD READ TO ME THIS STATEMENT WHICH BEGINS ON PAGE 1, AND ENDS ON PAGE 2. I FULLY UNDERSTAND THE CONTENTS OF THE ENTIRE STATEMENT MADE BY ME. THE STATEMENT IS TRUE. I HAVE INITIALED ALL CORRECTIONS AND HAVE INITIALED THE BOTTOM OF EACH PAGE CONTAINING THE STATEMENT. I HAVE MADE THIS STATEMENT FREELY WITHOUT HOPE OF BENEFIT OR REWARD, WITHOUT THREAT OF PUNISHMENT, AND WITHOUT COERCION, UNLAWFUL INF

(b)(3), (b)(6)  
(Signature of Person making Statement)

WITNESSES:

Subscribed and sworn to before me, a person authorized by law to administer oaths, this 22 day of OCTOBER, 2006

ORGANIZATION OR ADDRESS

(b)(3), (b)(6)  
(Typed Name of Person Administering Oath)

ORGANIZATION

(b)(3), (b)(6)

ARTICLE 136 (b) 4 UCMJ  
(Authority To Administer Oaths)

INITIALS OF

STATEMENT

PAGE 2 OF 2 PAGES

Privacy Act Statement  
(5 U.S.C. 522a)

AUTHORITY: 5 U.S.C.D. 301 and 10 U.S.C. 3012

PURPOSE: The purpose for collecting this information is to obtain facts and make recommendations to assist the appropriate authorities in determining what action to take with regard to: IED strike on 13 Oct, 06 at approx 2057H Resulting in Stanton KIA.

ROUTINE USES: Any information you provide is disclosable to members of the Department of Defense who have a need for the information in performance of their official duties, and where use of such information is compatible with the purpose for which the information is collected. In addition, the information may be disclosed to Government agencies and persons outside the Department of Defense for law enforcement purposes, or if determined to be disclosable pursuant to a request submitted under the Freedom of Information Act, or if needed for Congressional or other Government Investigations.

DISCLOSURE MANDATORY FOR INDIVIDUAL WHO MAY BE ORDERED TO TESTIFY: Providing the information is mandatory. Failure to provide information could result in disciplinary or other adverse action against you under the UCMJ or applicable Army or other federal regulations.

DISCLOSURE VOLUNTARY FOR INDIVIDUAL WARNED OF HIS RIGHTS UNDER ARTICLE 31, UCMJ, OR THE FIFTH AENDMENT OF THE U.S. CONSTITUTION: Providing the information is voluntary. There will be no adverse effect on you for not furnishing the information other than essential information that might not otherwise be available to the commander for his decision(s) in this matter.

ACKNOWLEDGMENT

The Privacy Act Statement above has been read to me and a copy of it has been provided to me. I understand its contents.

10-21-06  
Date

[Redacted Signature Box]  
(b)(3), (b)(6)

Printed Name and Rank

XII

SWORN STATEMENT

For use of this form, see AR 190-45; the proponent agency is PMG.

PRIVACY ACT STATEMENT

AUTHORITY: Title 10 USC Section 301; Title 5 USC Section 2951; E.O. 9397 dated November 22, 1943 (SSN).
PRINCIPAL PURPOSE: To provide commanders and law enforcement officials with means by which information may be accurately identified.
ROUTINE USES: Your social security number is used as an additional/alternate means of identification to facilitate filing and retrieval.
DISCLOSURE: Disclosure of your social security number is voluntary.

1. LOCATION Cp Liberty, Iraq 2. DATE (YYYYMMDD) 20061022 3. TIME 0830 4. FILE NUMBER

5. LAST NAME FIRST NAME MIDDLE NAME 6. SSN 7. GRADE/STATUS (b)(3), (b)(6)

8. ORGANIZATION OR ADDRESS 57th Military Police Company

9. (b)(3), (b)(6) I, (b)(3), (b)(6), WANT TO MAKE THE FOLLOWING STATEMENT UNDER OATH:

THIS STATEMENT IS INTENDED TO CLARIFY AND INVESTIGATE THE EVENTS OF 13 OCT 06.

(b)(3), (b)(6)

On the night of 13 October 2006 approximately at 2045 while conducting a mission in the Shula area, our convoy was struck by an Improvised Explosive Device. After driving around looking for suspicious activities in a swimming pool, known for insurgent activity. The convoy went back to route Mets, when my gunner (b)(3), (b)(6) informed me of two Iraqi Police patrol vehicles escorting a black vehicle (BMW) behind our convoy. My team was the rear element covering the SIX o'clock. I then reported to the (b)(3), (b)(6) about the situation. Quickly after, the two patrol vehicles escorting the BMW turned left going to the other side of "Shit Creek". They went about 300 meters away to our left hand side when the IP vehicles turned off their light bars. that's when we lost sight of them. Trying to look for them our convoy did an "u-turn" on Mets, the whole road was very dark. When about 200 meters into the road, in front of an open area to our right side the third vehicle was hit by an IED from the left side. The explosion sent shrapnel to our vehicle and the pressure moved us, my driver (b)(3), (b)(6) then stopped to recover himself and to see what was going on. The hit disabled the vehicle along with 2 WIA and 1 KIA. 1st Squad arrived on scene very quick bringing to medic (b)(3), (b)(6) to provide first aid and save the life of the two wounded taking them to the CASH. Our convoy recovered the disabled vehicle taking it to FOB Just (b)(3), (b)(6)

/// END OF STATEMENT ///

(b)(3), (b)(6)

10. EXHIBIT 11. INITIALS OF MAKING STATEMENT (b)(3), (b)(6) PAGE 1 OF 2 PAGES

ADDITIONAL PAGES MUST CONTAIN THE HEADING "STATEMENT OF \_\_\_\_\_ TAKEN AT \_\_\_\_\_ DATED \_\_\_\_\_"

THE BOTTOM OF EACH ADDITIONAL PAGE MUST BEAR THE INITIALS OF THE PERSON MADE MUST BE BE INDICATED.

X

STATEMENT (b)(3), (b)(6) TAKEN AT 6830 DATED 22 OCT 2006

9. STATEMENT (Continued)

[Redacted area with handwritten 'NOT USED' and a diagonal line]

(b)(3), (b)(6)

AFFIDAVIT

I, (b)(3), (b)(6), HAVE READ OR HAVE HAD READ TO ME THIS STATEMENT WHICH BEGINS ON PAGE 1, AND ENDS ON PAGE 2. I FULLY UNDERSTAND THE CONTENTS OF THE ENTIRE STATEMENT MADE BY ME. THE STATEMENT IS TRUE. I HAVE INITIALED ALL CORRECTIONS AND HAVE INITIALED THE BOTTOM OF EACH PAGE CONTAINING THE STATEMENT. I HAVE MADE THIS STATEMENT FREELY WITHOUT HOPE OF BENEFIT OR REWARD, WITHOUT THREAT OF PUNISHMENT, AND WITHOUT COERCION, UNLAWFUL INFLUENCE, OR UNLAWFUL INDUCEMENT.

WITNESSES:

(b)(3), (b)(6) Subscribed and sworn to before me, a person authorized by law to administer oaths, this 22 day of OCTOBER 2006 at Camp Liberty, Iraq

(b)(3), (b)(6) (Signature)

ORGANIZATION OR ADDRESS

(b)(3), (b)(6) (Typed Name of Person Administering Oath)

APC TS6 (b) 4, UCMJ (Authority To Administer Oaths)

ORGANIZATION OR ADDRESS

INITIALS OF (b)(3), (b)(6) STATEMENT

PAGE 2 OF 2 PAGES

Privacy Act Statement  
(5 U.S.C. 522a)

AUTHORITY: 5 U.S.C.D. 301 and 10 U.S.C. 3012

PURPOSE: The purpose for collecting this information is to obtain facts and make recommendations to assist the appropriate authorities in determining what action to take with regard to: FED STRIKE ON 13 OCT 06 AT APPROX. 2057 RESULTING IN STANTON KIA.

ROUTINE USES: Any information you provide is disclosable to members of the Department of Defense who have a need for the information in performance of their official duties, and where use of such information is compatible with the purpose for which the information is collected. In addition, the information may be disclosed to Government agencies and persons outside the Department of Defense for law enforcement purposes, or if determined to be disclosable pursuant to a request submitted under the Freedom of Information Act, or if needed for Congressional or other Government Investigations.

DISCLOSURE MANDATORY FOR INDIVIDUAL WHO MAY BE ORDERED TO TESTIFY: Providing the information is mandatory. Failure to provide information could result in disciplinary or other adverse action against you under the UCMJ or applicable Army or other federal regulations.

DISCLOSURE VOLUNTARY FOR INDIVIDUAL WARNED OF HIS RIGHTS UNDER ARTICLE 31, UCMJ, OR THE FIFTH AENDMENT OF THE U.S. CONSTITUTION: Providing the information is voluntary. There will be no adverse effect on you for not furnishing the information other than essential information that might not otherwise be available to the commander for his decision(s) in this matter.

ACKNOWLEDGMENT

The Privacy Act Statement above has been read to me and a copy of it has been provided to me. I understand its contents.

21 OCT 2006  
Date

(b)(3), (b)(6)

Printed Name and Rank

IX



SWORN STATEMENT

For use of this form, see AR 190-45, the proponent agency is PMG.

PRIVACY ACT STATEMENT

AUTHORITY: Title 10 USC Section 301; Title 5 USC Section 2951; E.O. 9397 dated November 22, 1943 (SSM).
PRINCIPAL PURPOSE: To provide commanders and law enforcement officials with means by which information may be accurately identified.
ROUTINE USES: Your social security number is used as an additional/alternate means of identification to facilitate filing and retrieval.
DISCLOSURE: Disclosure of your social security number is voluntary.

1. LOCATION: Camp Liberty, Iraq
2. DATE (YYYY): 2006/10
3. TIME: 0840
4. FILE NUMBER

(b)(3), (b)(6)

5. ORGANIZATION OR ADDRESS: 57th Military Police Company

(b)(3), (b)(6)

... WANT TO MAKE THE FOLLOWING STATEMENT UNDER OATH:

On 13 October 2006, we were driving on Creek Road headed east on a patrol in the Shulla area. I was the team leader for the second truck of the convoy. At approximately 2057 our convoy, the third truck, was struck by an EFP. We pushed through the kill zone and then set up a cordon to provide security, resulted no sign of enemy movement. Our Squad and First Squad administered aid and security. Resulted in two WIAs and one KIA. First squad took the two wounded personnel to the CASH. We towed the disabled vehicle to Fob Justice to further access the situation. Resulted with no new injuries or damage to equipment. The grid coordinate of the EFP attack was MB32459207. Prior to the mission all PCIs and PCCs was completed by myself and the squad leader. All TTPs were followed, all four trucks had working Warlocks and the first two trucks had working... All personnel in the squad were wearing their protective gear at the time of the attack. ////END OF STATEMENT//

(b)(1)1.4a

(b)(3), (b)(6)

10. EXHIBIT 11. INITIALS: (b)(3), (b)(6) MAKING STATEMENT PAGE 1 OF 1 PAGES

ADDITIONAL PAGES MUST CONTAIN THE HEADING "STATEMENT OF ... TAKEN AT ... DATED ..."

THE BOTTOM OF EACH ADDITIONAL PAGE MUST BEAR THE INITIALS OF THE PERSON MAKING STATEMENT. MUST BE BE INDICATED.

VIII

(b)(3), (b)(6)

INITIALS OF PERSON MAKING STATEMENT

ORGANIZATION OR ADDRESS

(Authority To Administer Oaths)

Article 136(b)(1), UCMJ

(Typed Name of Person Administering Oath)

(b)(3), (b)(6)

ORGANIZATION OR ADDRESS

(Typed Name of Person Administering Oath)

(b)(3), (b)(6)

at Camp

administer oaths, this 21st day of October, 2006. Subscribed and sworn to before me, a person authorized by law to

WITNESSES:

(Signature of Person Making Statement)

(b)(3), (b)(6)

I, \_\_\_\_\_, HAVE READ OR HAVE HAD READ TO ME THIS STATEMENT WHICH BEGINS ON PAGE \_\_\_\_\_, I FULLY UNDERSTAND THE CONTENTS OF THE ENTIRE STATEMENT MADE BY ME. THE STATEMENT IS TRUE. I HAVE INITIALED ALL CORRECTIONS AND HAVE INITIALED THE BOTTOM OF EACH PAGE CONTAINING THE STATEMENT. I HAVE MADE THIS STATEMENT FREELY WITHOUT HOPE OF BENEFIT OR REWARD, WITHOUT THREAT OF PUNISHMENT, AND WITHOUT COERCION, UNLAWFUL INFLUENCE, OR UNLAWFUL INDUCEMENT.

AFFIDAVIT

(b)(3), (b)(6)

9. STATEMENT (Continued)

DATED

TAKEN AT

STATEMENT OF

Privacy Act Statement  
(5 U.S.C. 522a)

AUTHORITY: 5 U.S.C. 301 and 10 U.S.C. 3012

PURPOSE: The purpose for collecting this information is to obtain facts and make recommendations to assist the appropriate authorities in determining what action to take with regard to: IED STRIKE ON  
13 Oct 06 At APPROX. 2057 Resulting in Stanton KIA

ROUTINE USES: Any information you provide is disclosable to members of the Department of Defense who have a need for the information in performance of their official duties, and where use of such information is compatible with the purpose for which the information is collected. In addition, the information may be disclosed to Government agencies and persons outside the Department of Defense for law enforcement purposes, or if determined to be disclosable pursuant to a request submitted under the Freedom of Information Act, or if needed for Congressional or other Government Investigations.

DISCLOSURE MANDATORY FOR INDIVIDUAL WHO MAY BE ORDERED TO TESTIFY: Providing the information is mandatory. Failure to provide information could result in disciplinary or other adverse action against you under the UCMJ or applicable Army or other federal regulations.

DISCLOSURE VOLUNTARY FOR INDIVIDUAL WARNED OF HIS RIGHTS UNDER ARTICLE 31, UCMJ, OR THE FIFTH AENDMENT OF THE U.S. CONSTITUTION: Providing the information is voluntary. There will be no adverse effect on you for not furnishing the information other than essential information that might not otherwise be available to the commander for his decision(s) in this matter.

ACKNOWLEDGMENT

The Privacy Act Statement above has been read to me and a copy of it has been provided to me. I understand its contents.

21 OCT 06  
Date

(b)(3), (b)(6)

VII

SWORN STATEMENT

For use of this form, see AR 190-45; the proponent agency is PMG.

PRIVACY ACT STATEMENT

AUTHORITY: Title 10 USC Section 301; Title 5 USC Section 2951; E.O. 9397 dated November 22, 1943 (SSN).
PRINCIPAL PURPOSE: To provide commanders and law enforcement officials with means by which information may be accurately identified.
ROUTINE USES: Your social security number is used as an additional/alternate means of identification to facilitate filing and retrieval.
DISCLOSURE: Disclosure of your social security number is voluntary.

1. LOCATION: Camp Liberty, Iraq
2. DATE (YYYYMM): 2006/10/08
3. TIME: 08:55
4. FILE NUMBER: (b)(3), (b)(6)

5. LAST NAME, FIRST NAME, MIDDLE NAME: (b)(3), (b)(6)

8. ORGANIZATION OR ADDRESS: 57th Military Police Company

9. (b)(3), (b)(6) ... WANT TO MAKE THE FOLLOWING STATEMENT UNDER OATH:

On Friday October 13, 2006, we were driving down Creek Road headed east on a patrol in the Shula area, while on patrol I was the gunner for the third truck that got attacked by an EFP, the other vehicles in the convoy pushed through the kill zone and then set up a cordon to provide security, resulted no sign of enemy movement. The rest of my squad provided first aid to my team leader (b)(3), (b)(6) and provided security. Result me and my team leader wounded and PFC Stanton KIA. I was taken to the hospital (CASTR) for further medical evaluation. The time of the EFP was approx. 2057 at grid coordinate MB32459207. Prior to the mission all PCI's and PCC's were conducted by the team leaders and squad leader. All TTPs were followed. The four trucks had working (b)(1)1.4a and the first two trucks had working (b)(1)1.4a All personnel that were in the third truck of which I was the gunner facing the 3 o'clock direction, were wearing all their protective gear.///END OF STATEMENT/// (b)(3), (b)(6)

10. EXHIBIT
11. INITIALS OF PERSON MAKING STATEMENT: (b)(3), (b)(6)
PAGE 1 OF 1 PAGES

ADDITIONAL PAGES MUST CONTAIN THE HEADING "STATEMENT OF \_\_\_\_\_ TAKEN AT \_\_\_\_\_ DATED \_\_\_\_\_
THE BOTTOM OF EACH ADDITIONAL PAGE MUST BEAR THE INITIALS OF THE PERSON MAKING STATEMENT AND MUST BE INDICATED

Handwritten Roman numeral IV

INITIALS OF PERSON STATEMENT (b)(3), (b)(6)

ORGANIZATION OR ADDRESS

(Authority To Administer Oaths)

Article 136(b)(1), UCMJ

(Typed Name of Person Administering Oath)

(b)(3), (b)(6)

ORGANIZATION OR ADDRESS

(b)(3), (b)(6)

at Camp Liberty, Iraq

administer oaths, this 21st day of October, 2006

Subscribed and sworn to before me, a person authorized by law to

WITNESSES:

(Signature of Person Making Statement)

(b)(3), (b)(6)

I HAVE READ OR HAVE HAD READ TO ME THIS STATEMENT WHICH BEGINS ON PAGE 1, AND ENDS ON PAGE 2. I FULLY UNDERSTAND THE CONTENTS OF THE ENTIRE STATEMENT MADE BY ME. THE STATEMENT IS TRUE. I HAVE INITIALED ALL CORRECTIONS AND HAVE INITIALED THE BOTTOM OF EACH PAGE CONTAINING THE STATEMENT. I HAVE MADE THIS STATEMENT FREELY WITHOUT HOPE OF BENEFIT OR REWARD, WITHOUT THREAT OF PUNISHMENT, AND WITHOUT COERCION, UNLAWFUL INFLUENCE OR UNLAWFUL INDUCEMENT.

AFFIDAVIT

(b)(3), (b)(6)

APPROVED FOR RELEASE

9. STATEMENT (Continued)

STATEMENT OF

TAKEN AT

DATED

Privacy Act Statement  
(5 U.S.C. 522a)

AUTHORITY: 5 U.S.C.D. 301 and 10 U.S.C. 3012

PURPOSE: The purpose for collecting this information is to obtain facts and make recommendations to assist the appropriate authorities in determining what action to take with regard to: IED strike on  
13 Oct 06 at approx 2057 resulting in Stanton  
KIA

ROUTINE USES: Any information you provide is disclosable to members of the Department of Defense who have a need for the information in performance of their official duties, and where use of such information is compatible with the purpose for which the information is collected. In addition, the information may be disclosed to Government agencies and persons outside the Department of Defense for law enforcement purposes, or if determined to be disclosable pursuant to a request submitted under the Freedom of Information Act, or if needed for Congressional or other Government Investigations.

DISCLOSURE MANDATORY FOR INDIVIDUAL WHO MAY BE ORDERED TO TESTIFY: Providing the information is mandatory. Failure to provide information could result in disciplinary or other adverse action against you under the UCMJ or applicable Army or other federal regulations.

DISCLOSURE VOLUNTARY FOR INDIVIDUAL WARNED OF HIS RIGHTS UNDER ARTICLE 31, UCMJ, OR THE FIFTH AENDMENT OF THE U.S. CONSTITUTION: Providing the information is voluntary. There will be no adverse effect on you for not furnishing the information other than essential information that might not otherwise be available to the commander for his decision(s) in this matter.

ACKNOWLEDGMENT

The Privacy Act Statement above has been read to me and a copy of it has been provided to me. I understand its contents.

10/21/2006  
Date

(b)(3), (b)(6)

XIV

SWORN STATEMENT

For use of this form, see AR 190-45; the proponent agency is PMG.

PRIVACY ACT STATEMENT

AUTHORITY: Title 10 USC Section 301; Title 5 USC Section 2951; E.O. 9397 dated November 22, 1943 (SSN).
PRINCIPAL PURPOSE: To provide commanders and law enforcement officials with means by which information may be accurately identified.
ROUTINE USES: Your social security number is used as an additional/alternate means of identification to facilitate filing and retrieval.
DISCLOSURE: Disclosure of your social security number is voluntary.

1. LOCATION: CAMP VICTORY, IRAQ
2. DATE (YYYYMMDD): 2006/10/21
3. TIME: 0704
4. FILE NUMBER

(b)(3), (b)(6)

8. ORGANIZATION OR ADDRESS: 57th MP CO.

9. (b)(3), (b)(6) WANT TO MAKE THE FOLLOWING STATEMENT UNDER OATH:

(b)(3), (b)(6) 06 while on patrol in the Shula area on Creek we were attacked by unknown person(s) at Grid MB324592075 at approximately 2057. I was looking to the front of the vehicle looking for a black BMW when I heard a loud boom and felt the concussion vibrate the entire vehicle. I looked up to check if my gunner was injured. My (b)(3), (b)(6) yelled out that we were getting attacked and to get out of the kill zone. I was told to step on the gas and a few seconds later to turn around and go back after we realized only one truck was with us. I look in my side mirror to see if I could see the other trucks. That is when (b)(3), (b)(6) said (b)(3), (b)(6) truck was hit. I was told to back up and start setting up a cordon and security. (b)(3), (b)(6) was en route to one location upon going to the scene I saw (b)(3), (b)(6) on the ground. at that time (b)(3), (b)(6) and (b)(3), (b)(6) were on scene too. (b)(3), (b)(6) was running up to treating (b)(3), (b)(6) my truck was backing up to tow 155 to FOB Justice. (b)(3), (b)(6) and his squad took the wounded to the CASH. Everyone had all there protective gear on and the (b)(3), (b)(6) was on so was the (b)(3), (b)(6) All TTP's were followed All reports were sent up to the TOC. We found out that somebody set an IED at us hitting the third vehicle. The M1114 was heavily damaged with 1 KIA (Stanton) and 2 WIA (b)(3), (b)(6)

10. EXHIBIT

11. INITIALS (b)(3), (b)(6) MAKING STATEMENT

PAGE 1 OF 2 PAGES

ADDITIONAL PAGES MUST CONTAIN THE HEADING "STATEMENT OF TAKEN AT DATED

THE BOTTOM OF EACH ADDITIONAL PAGE MUST BEAR THE INITIALS OF THE PERSON MAKING IT MUST BE BE INDICATED.

XVI

INITIALS OF MAKING STATEMENT (b)(3), (b)(6)

ORGANIZATION OR ADDRESS

(Authority To Administer Oaths)

(Typed Name of Person Administering Oath)

(b)(3), (b)(6)

ORGANIZATION OR ADDRESS

(Typed Name of Person Administering Oath)

(b)(3), (b)(6)

WITNESSES:

Subscribed and sworn to before me, a person authorized by law to administer oaths, this 21st day of October, 2006

(Making Statement)

(b)(3), (b)(6)

I, (b)(3), (b)(6), HAVE READ OR HAVE HAD READ TO ME THIS STATEMENT WHICH BEGINS ON PAGE 1 AND ENDS ON PAGE 2. I FULLY UNDERSTAND THE CONTENTS OF THE ENTIRE STATEMENT MADE BY ME. THE STATEMENT IS TRUE. I HAVE INITIALED ALL CORRECTIONS AND HAVE INITIALED THE BOTTOM OF EACH PAGE CONTAINING THE STATEMENT. I HAVE MADE THIS STATEMENT FREELY WITHOUT HOPE OF BENEFIT OR REWARD, WITHOUT THREAT OF PUNISHMENT, AND WITHOUT COERCION, UNLAWFUL INFLUENCE, OR UNLAWFUL INDUCEMENT.

AFFIDAVIT

9. STATEMENT (Continued)

STATEMENT OF

TAKEN AT

DATED



Privacy Act Statement  
(5 U.S.C. 522a)

AUTHORITY: 5 U.S.C.D. 301 and 10 U.S.C. 3012

PURPOSE: The purpose for collecting this information is to obtain facts and make recommendations to assist the appropriate authorities in determining what action to take with regard to: IED strike on

13 Oct 06 at approx. 2057 resulting in Stanton KIA.

ROUTINE USES: Any information you provide is disclosable to members of the Department of Defense who have a need for the information in performance of their official duties, and where use of such information is compatible with the purpose for which the information is collected. In addition, the information may be disclosed to Government agencies and persons outside the Department of Defense for law enforcement purposes, or if determined to be disclosable pursuant to a request submitted under the Freedom of Information Act, or if needed for Congressional or other Government Investigations.

DISCLOSURE MANDATORY FOR INDIVIDUAL WHO MAY BE ORDERED TO TESTIFY: Providing the information is mandatory. Failure to provide information could result in disciplinary or other adverse action against you under the UCMJ or applicable Army or other federal regulations.

DISCLOSURE VOLUNTARY FOR INDIVIDUAL WARNED OF HIS RIGHTS UNDER ARTICLE 31, UCMJ, OR THE FIFTH AENDMENT OF THE U.S. CONSTITUTION: Providing the information is voluntary. There will be no adverse effect on you for not furnishing the information other than essential information that might not otherwise be available to the commander for his decision(s) in this matter.

ACKNOWLEDGMENT

The Privacy Act Statement above has been read to me and a copy of it has been provided to me. I understand its contents.

21 Oct 06  
Date

(b)(3), (b)(6)  
Printed Name and Rank

XVII

SWORN STATEMENT

For use of this form, see AR 190-45; the proponent agency is PMG.

PRIVACY ACT STATEMENT

AUTHORITY: Title 10 USC Section 301; Title 5 USC Section 2951; E.O. 9397 dated November 22, 1943 (SSA).
PRINCIPAL PURPOSE: To provide commanders and law enforcement officials with means by which information may be accurately identified.
ROUTINE USES: Your social security number is used as an additional/alternate means of identification to facilitate filing and retrieval.
DISCLOSURE: Disclosure of your social security number is voluntary.

1. LOCATION Cp Liberty, Iraq 2. DATE (YYYYMM) 2006/10/22 3. FILE NUMBER (b)(3), (b)(6)

57th Military Police Company

9. I, (b)(3), (b)(6), WANT TO MAKE THE FOLLOWING STATEMENT UNDER OATH:

THIS STATEMENT IS INTENDED TO CLARIFY AND INVESTIGATE THE EVENTS OF 13 OCT 06.

(b)(3), (b)(6)

On the 13th of Oct. at approximately 20:00 in the Shula district an IED went off. We were driving down Mets going east when I seen an IP vehicle escorting a Black BMW. They were coming too close to our convoy when I had pointed my green laser on them. They then proceeded to take a left onto Shit Creek Rd. heading towards Gazalea Main. I then told my (b)(3), (b)(6) about the situation. He (b)(3), (b)(6) then reported it up to the (b)(3), (b)(6) of the convoy. We then started to go towards the IP vehicle to stop and ask them, why they were escorting this vehicle. As we were getting closer to the turn from Mets to Shit Creek rd. I glanced back at Shit Creek rd. that was horizontal to us to see if I could still see the IP vehicle. As I glanced over I could not see them. I ask my Team Leader if he could see them and he stated that they had shut their lights off and had left. We then turned on Shit Creek rd going towards Gazalea Main, and the Squad Leader realized that it was the other way and we made a U-turn and went back toward Mets on Shit Creek rd. As we were driving down Shit Creek Rd I had seen a flash. I thought it was lightning. Then the explosion came from behind me. I really didn't see exactly where it was because I was rear security. We then began to push through the kill zone and check to make sure everyone was alright when I realized that a vehicle in our convoy had been hit by an IED. I then informed my Team Leader that there was still a vehicle back there. We then went back, while my team went out and assisted the down vehicle I pulled security and did my 5-25's. After the call was made and 1st squad had responded, they had left to take the wounded to the CASH. We began to get into position to tow the vehicle to FOB Justice. My team then took the lead of the convoy to FOB Justice to where we waited there for 2nd platoon and the PSD squad. We then meet up with them and began to head back to FOB Libe (b)(3), (b)(6)

1001 ENDS OF STATEMENT / /

10. EXHIBIT 11. INITIALS (b)(3), (b)(6) ON MAKING STATEMENT PAGE 1 OF 2 PAGES

ADDITIONAL PAGES MUST CONTAIN THE HEADING "STATEMENT OF \_\_\_\_\_ TAKEN AT \_\_\_\_\_ DATED \_\_\_\_\_"

THE BOTTOM OF EACH ADDITIONAL PAGE MUST BEAR THE INITIALS OF THE PERSON MADE. MUST BE BE INDICATED.

XVIII

STATEMENT OF (b)(3), (b)(6) TAKEN AT 07:55 (b)(3), (b)(6) DATED 22 Oct 06 (b)(3), (b)(6)

9. STATEMENT (Continued)

END OF STATEMENT NOT USED

AFFIDAVIT

I, (b)(3), (b)(6), HAVE READ OR HAVE HAD READ TO ME THIS STATEMENT WHICH BEGINS ON PAGE 1, AND ENDS ON PAGE 2. I FULLY UNDERSTAND THE CONTENTS OF THE ENTIRE STATEMENT MADE BY ME. THE STATEMENT IS TRUE. I HAVE INITIALED ALL CORRECTIONS AND HAVE INITIALED THE BOTTOM OF EACH PAGE CONTAINING THE STATEMENT. I HAVE MADE THIS STATEMENT FREELY WITHOUT HOPE OF BENEFIT OR REWARD, WITHOUT THREAT OF PUNISHMENT, AND WITHOUT COERCION, UNLAWFUL INFLUENCE

(b)(3), (b)(6)

WITNESSES:

Subscribed and sworn to before me, a person authorized by law to administer oaths, this 22 day of OCTOBER, 2006 at CAMP LIBERTY TRAIL

ORGANIZATION OR ADDRESS  
ORGANIZATION OR ADDRESS

(b)(3), (b)(6)

(Typed Name of Person Administering Oath)

ARTICLE 136 (b) 4 UCMJ  
(Authority To Administer Oaths)

INITIALS OF PERSON STATEMENT (b)(3), (b)(6)

Privacy Act Statement  
(5 U.S.C. 522a)

AUTHORITY: 5 U.S.C.D. 301 and 10 U.S.C. 3012

PURPOSE: The purpose for collecting this information is to obtain facts and make recommendations to assist the appropriate authorities in determining what action to take with regard to: IED strike on

13 Oct 06 at approx. 2057 resulting in Stanton KIA

ROUTINE USES: Any information you provide is disclosable to members of the Department of Defense who have a need for the information in performance of their official duties, and where use of such information is compatible with the purpose for which the information is collected. In addition, the information may be disclosed to Government agencies and persons outside the Department of Defense for law enforcement purposes, or if determined to be disclosable pursuant to a request submitted under the Freedom of Information Act, or if needed for Congressional or other Government Investigations.

DISCLOSURE MANDATORY FOR INDIVIDUAL WHO MAY BE ORDERED TO TESTIFY: Providing the information is mandatory. Failure to provide information could result in disciplinary or other adverse action against you under the UCMJ or applicable Army or other federal regulations.

DISCLOSURE VOLUNTARY FOR INDIVIDUAL WARNED OF HIS RIGHTS UNDER ARTICLE 31, UCMJ, OR THE FIFTH AENDMENT OF THE U.S. CONSTITUTION: Providing the information is voluntary. There will be no adverse effect on you for not furnishing the information other than essential information that might not otherwise be available to the commander for his decision(s) in this matter.

ACKNOWLEDGMENT

The Privacy Act Statement above has been read to me and a copy of it has been provided to me. I understand its contents.

21 OCT 2006  
Date

(b)(3), (b)(6)

Printed Name and Rank

XIX

UNCLASSIFIED  
SWORN STATEMENT

For use of this form, see AR 190-45; the proponent agency is [redacted] MG.

PRIVACY ACT STATEMENT

AUTHORITY: Title 10 USC Section 301; Title 5 USC Section 2951; E.O. 9397 dated November 22, 1943 (SSM).  
PRINCIPAL PURPOSE: To provide commanders and law enforcement officials with means by which information may be accurately identified.  
ROUTINE USES: Your social security number is used as an additional/alternate means of identification to facilitate filing and retrieval.  
DISCLOSURE: Disclosure of your social security number is voluntary.

1. LOCATION: CAMP VICTORY, IRAQ  
2. DATE (YYYYMM): 2006/10/21  
3. [redacted] (b)(3), (b)(6)  
4. FILE NUMBER: 0651

8. ORGANIZATION OR ADDRESS: 57th MP CO.

9. [redacted] (b)(3), (b)(6), WANT TO MAKE THE FOLLOWING STATEMENT UNDER OATH:

(b)(3), (b)(6)  
On 13 Oct 06 while on patrol in the Shula area on Creek we were attacked by unknown person(s) at Grid MB32459207 at approximately 2057. I was looking out the left side of the gunners turret for a black BMW when I heard a loud boom and felt the concussion vibrate the entire vehicle. I was knocked into the right side of the turret. From the blast I looked down to check if my driver [redacted] (b)(3), (b)(6) was injured. My [redacted] (b)(3), (b)(6) yelled out that we were getting attacked and to get out of the kill zone. I was told to look for secondary devices. When [redacted] (b)(3), (b)(6) only one truck was with us. We turned around to see if I could see the other trucks. That is when [redacted] (b)(3), (b)(6) said [redacted] (b)(3), (b)(6) truck was hit. I was told to be alert and start setting up a cordon and security. [redacted] (b)(3), (b)(6) was en route to our location. Upon going to the scene I saw [redacted] (b)(3), (b)(6) on the ground. at that time [redacted] (b)(3), (b)(6) and [redacted] (b)(3), (b)(6) were on scene too. [redacted] (b)(3), (b)(6) was running up to [redacted] (b)(3), (b)(6) my truck was the rear truck providing security. Our first truck [redacted] (b)(3), (b)(6) and the gunner [redacted] (b)(3), (b)(6) looked up to truck 133 and towed it to FOB Justice. [redacted] (b)(3), (b)(6) and his squad took the wounded to the CASH. Everyone had all their protective gear on and the rhino was on so was the [redacted] (b)(1)1.4. All TTP's were followed All reports were sent up to the TOC. We found out that somebody got of an EFP at us hitting the third vehicle. The M1114 was heavy damaged with 1 KIA (Stanton) and 2 WIA [redacted] (b)(3), (b)(6)

10. EXHIBIT: [redacted]  
11. INITIALS IN MAKING STATEMENT: [redacted] (b)(3), (b)(6)  
PAGE 1 OF 2 PAGES

ADDITIONAL PAGES MUST CONTAIN THE HEADING "STATEMENT OF \_\_\_\_\_ TAKEN AT \_\_\_\_\_ DATED \_\_\_\_\_"  
THE BOTTOM OF EACH ADDITIONAL PAGE MUST BEAR THE INITIALS OF THE PERSON MAKING THE STATEMENT. AND PAGE NUMBER MUST BE BE INDICATED.

XX

INITIALS (b)(3), (b)(6) STATEMENT

ORGANIZATION OR ADDRESS

(Authority To Administer Oaths)

Article 136(b)4, UCMJ

(Typed Name of Person Administering Oath)

(b)(3), (b)(6)

ORGANIZATION OR ADDRESS

(Signature of Person Administering Oath)

(b)(3), (b)(6)

at Camp Liberty, Iraq

administer oaths, this 21st day of October, 2006

Subscribed and sworn to before me, a person authorized by law to

WITNESSES:

(b)(3), (b)(6)

THREAT OF PUNISHMENT, AND WITHOUT COERCION, UNLAWFUL INFLUENCE OR UNLAWFUL INDUCEMENT. BY ME, THE STATEMENT IS TRUE. I HAVE MADE THIS STATEMENT FREELY WITHOUT HOPE OF BENEFIT OR REWARD, WITHOUT

HAVE READ OR HAVE HAD READ TO ME THIS STATEMENT PAGE I FULLY UNDERSTAND THE CONTENTS OF THE ENTIRE STATEMENT MADE

(b)(3), (b)(6)

AFFIDAVIT

9. STATEMENT (Continued)

STATEMENT OF

TAKEN AT

DATED

Privacy Act Statement  
(5 U.S.C. 522a)

AUTHORITY: 5 U.S.C. 301 and 10 U.S.C. 3012

PURPOSE: The purpose for collecting this information is to obtain facts and make recommendations to assist the appropriate authorities in determining what action to take with regard to: FED Strike on

13 Oct 06 at approx 2057 Resulting in station KIA.

ROUTINE USES: Any information you provide is disclosable to members of the Department of Defense who have a need for the information in performance of their official duties, and where use of such information is compatible with the purpose for which the information is collected. In addition, the information may be disclosed to Government agencies and persons outside the Department of Defense for law enforcement purposes, or if determined to be disclosable pursuant to a request submitted under the Freedom of Information Act, or if needed for Congressional or other Government Investigations.

DISCLOSURE MANDATORY FOR INDIVIDUAL WHO MAY BE ORDERED TO TESTIFY: Providing the information is mandatory. Failure to provide information could result in disciplinary or other adverse action against you under the UCMJ or applicable Army or other federal regulations.

DISCLOSURE VOLUNTARY FOR INDIVIDUAL WARNED OF HIS RIGHTS UNDER ARTICLE 31, UCMJ, OR THE FIFTH AENDMENT OF THE U.S. CONSTITUTION: Providing the information is voluntary. There will be no adverse effect on you for not furnishing the information other than essential information that might not otherwise be available to the commander for his decision(s) in this matter.

ACKNOWLEDGMENT

The Privacy Act Statement above has been read to me and a copy of it has been provided to me. I understand its contents.

21 Oct 06  
Date

(b)(3), (b)(6)

Printed Name and Rank

**XXI**

SWORN STATEMENT

For use of this form, see AR 190-45; the proponent agency is PMG.

PRIVACY ACT STATEMENT

AUTHORITY: Title 10 USC Section 301; Title 5 USC Section 2951; E.O. 9397 dated November 22, 1943 (SSN).
PRINCIPAL PURPOSE: To provide commanders and law enforcement officials with means by which information may be accurately identified.
ROUTINE USES: Your social security number is used as an additional/alternate means of identification to facilitate filing and retrieval.
DISCLOSURE: Disclosure of your social security number is voluntary.

1. LOCATION: CAMP LIBERTY, IRAQ
2. DATE (YYYYMMDD): 2006/10/21
3. FILE NUMBER: 0655

(b)(3), (b)(6)

6. ORGANIZATION OR ADDRESS: 57TH MILITARY POLICE COMPANY

9. (b)(3), (b)(6) WANT TO MAKE THE FOLLOWING STATEMENT UNDER OATH:

(b)(3), (b)(6) On 13 Oct 06 while on patrol in the Shula area traveling east on Creek doing about 25 MPH with 40 meters distance between vehicles we were attacked by unknown person(s) at Grid MB32459207 at approximately 2057. I was looking to the front of the vehicle looking for a black BMW with an Iraq Police escort when I heard a loud boom and felt the concussion vibrate the entire vehicle. I looked up at the gunner (b)(3), (b)(6) to make sure he was down in the turret. I yelled out that we were getting attacked and to get out of the kill zone. I told my driver (b)(3), (b)(6) to step on the gas as I was trying to get a status on the rest of my convoy to make sure everybody was all right. Only one truck was with me. I look in my side mirror to see if I could see the other trucks. That is when (b)(3), (b)(6) said (b)(3), (b)(6) truck was hit. I to (b)(3), (b)(6) turn around and start setting up a cordon and security (b)(3), (b)(6) (b)(3), (b)(6) was en route to our location. Upon going to the scene I saw (b)(3), (b)(6) on the ground at that time (b)(3), (b)(6) (b)(3), (b)(6) (b)(3), (b)(6) were on scene too. (b)(3), (b)(6) was running up to treat (b)(3), (b)(6) for her injuries my truck was backing up to low 1.33 to FOB Justice. (b)(3), (b)(6) and his squad took the wounded to the CASH. Everyone had all there protective gear on and the (b)(3), (b)(6) is on so was the warlock. 4 vehicles had (b)(3), (b)(6) and the 2 front vehicles had rhinos. All TTP's were followed All reports were sent up to the TOC. We found out (b)(3), (b)(6) set of an EFP at us hitting the third vehicle. The M114 was heavy damaged with 1 KIA (Stanton) and 2 WIA (b)(3), (b)(6) Prior to the mission all commo checks. PCIs and PCC were conducted by my Team Leaders and myself (b)(3), (b)(6)

10. EXHIBIT 11. INITIALS OF MAKING STATEMENT (b)(3), (b)(6) PAGE 1 OF 2 PAGES

ADDITIONAL PAGES MUST CONTAIN THE HEADING "STATEMENT OF TAKEN AT DATED

THE BOTTOM OF EACH ADDITIONAL PAGE MUST BEAR THE INITIALS OF THE PERSON MAKING TI MUST BE BE INDICATED.

XXII



(b)(3), (b)(6)

INITIALS OF PERSON MAKING STATEMENT

ORGANIZATION OR ADDRESS

(Authority To Administer Oaths)

Article 136(b)(4), UCMJ

(Typed Name of Person Administering Oath)

(b)(3), (b)(6)

(Signature of Person Administering Oath)

(b)(3), (b)(6)

at Camp Liberty, Iraq

administer oaths, this 21st day of October, 2006

Subscribed and sworn to before me, a person authorized by law to

WITNESSES:

(Statement)

(b)(3), (b)(6)

HAVE READ OR HAVE HAD READ TO ME THIS STATEMENT WHICH BEGINS ON PAGE 1, I FULLY UNDERSTAND THE CONTENTS OF THE ENTIRE STATEMENT MADE BY ME. THE STATEMENT IS TRUE. I HAVE INITIALED ALL CORRECTIONS AND HAVE INITIALED THE BOTTOM OF EACH PAGE CONTAINING THE STATEMENT. I HAVE MADE THIS STATEMENT FREELY WITHOUT HOPE OF BENEFIT OR REWARD, WITHOUT THREAT OF PUNISHMENT, AND WITHOUT COERCION, UNLAWFUL INFLUENCE OR UNLAWFUL INDUCEMENT.

(b)(3), (b)(6)

AFFIDAVIT

APPROVED FOR RELEASE

Privacy Act Statement  
(5 U.S.C. 522a)

AUTHORITY: 5 U.S.C.D. 301 and 10 U.S.C. 3012

PURPOSE: The purpose for collecting this information is to obtain facts and make recommendations to assist the appropriate authorities in determining what action to take with regard to: IED Strike on

13 Oct 06 AT Approx 2057 resulting in  
Stanton KIA

ROUTINE USES: Any information you provide is disclosable to members of the Department of Defense who have a need for the information in performance of their official duties, and where use of such information is compatible with the purpose for which the information is collected. In addition, the information may be disclosed to Government agencies and persons outside the Department of Defense for law enforcement purposes, or if determined to be disclosable pursuant to a request submitted under the Freedom of Information Act, or if needed for Congressional or other Government Investigations.

DISCLOSURE MANDATORY FOR INDIVIDUAL WHO MAY BE ORDERED TO TESTIFY: Providing the information is mandatory. Failure to provide information could result in disciplinary or other adverse action against you under the UCMJ or applicable Army or other federal regulations.

DISCLOSURE VOLUNTARY FOR INDIVIDUAL WARNED OF HIS RIGHTS UNDER ARTICLE 31, UCMJ, OR THE FIFTH AENDMENT OF THE U.S. CONSTITUTION: Providing the information is voluntary. There will be no adverse effect on you for not furnishing the information other than essential information that might not otherwise be available to the commander for his decision(s) in this matter.

ACKNOWLEDGMENT

The Privacy Act Statement above has been read to me and a copy of it has been provided to me. I understand its contents.

21 Oct 06  
Date

(b)(3), (b)(6)

**XXIII**

SWORN STATEMENT

For use of this form, see AR 190-45; the proponent agency is PMG.

PRIVACY ACT STATEMENT

AUTHORITY: Title 10 USC Section 301; Title 5 USC Section 2951; E.O. 9397 dated November 22, 1943 (SSN).
PRINCIPAL PURPOSE: To provide commanders and law enforcement officials with means by which information may be accurately identified.
ROUTINE USES: Your social security number is used as an additional/alternate means of identification to facilitate filing and retrieval.
DISCLOSURE: Disclosure of your social security number is voluntary.

1. LOCATION: Camp Liberty, Iraq
2. DATE (YYYYMM): 2006/10/2
3. TIME: 0847
FILE NUMBER: (b)(3), (b)(6)

(b)(3), (b)(6)

8. ORGANIZATION OR ADDRESS: 57th Military Police Company

(b)(3), (b)(6)

... WANT TO MAKE THE FOLLOWING STATEMENT UNDER OATH:

On Friday October 13, 2006, we were driving down Creek Road headed east on a patrol in the Shula area. Our convoy, the third truck, was struck by an EFP. We pushed through the kill zone and then set up a cordon to provide security. Resulted no sign of enemy movement. Our Squad and Frist Squad administered aid and security. Resulted in two WIAs and one KIA. We towed the disabled vehicle to Fob Justice to further assesst the situation. Resulted with no new injuries or damage to equipment. The time of the EFP was approx. 2057 at grid cordnate MB32459207. Prior to the mission all PCs and PCCs were equipped by the team leader and squad leader. all four trucks had working (b)(1)1.4a and the first two trucks had working (b)(1)1.4a. All personal that were in the second truck of which I was driving, were wearing all their protective gear.//END OF STATEMENT/// (b)(3), (b)(6)

APPROVED FOR RELEASE

10. EXHIBIT
11. INITIALS OF MAKING STATEMENT: (b)(3), (b)(6)
PAGE 1 OF 1 PAGES

ADDITIONAL PAGES MUST CONTAIN THE HEADING "STATEMENT OF ... TAKEN AT ... DATED ..."

THE BOTTOM OF EACH ADDITIONAL PAGE MUST BEAR THE INITIALS OF THE PERSON MAKING MUST BE BE INDICATED.

XXIV

STATEMENT

(b)(3), (b)(6)

INITIALS OF F

ORGANIZATION OR ADDRESS

(Authority To Administer Oaths)

Article 136(b)4, UCMJ

(Typed Name of Person Administering Oath)

(b)(3), (b)(6)

ORGANIZATION OR ADDRESS

(Administering Oath)

(b)(3), (b)(6)

at

administered oaths this 21st day of October 2006

WITNESSES:

(b)(3), (b)(6)

THREAT OF PUNISHMENT, AND WITHOUT COERCION, UN

WHICH BEGINS ON PAGE 1 AND ENDS ON PAGE 2. I FULLY UNDERSTAND THE CONTENTS OF THE ENTIRE STATEMENT MADE BY ME. THE STATEMENT IS TRUE. I HAVE INITIALED ALL CORRECTIONS AND HAVE INITIALED THE BOTTOM OF EACH PAGE

AFFIDAVIT

(b)(3), (b)(6)

9. STATEMENT (Continued)

STATEMENT OF

TAKEN AT

DATED

APPROVED FOR RELEASE

9. COMMANDER REPORTING: [REDACTED] (b)(3), (b)(6)

II

6. SUMMARY OF INCIDENT: ON 132110COCT06 WHILE CENTURION 2-1 WAS CONDUCTING A MOUNTED PATROL AT MB 33245 92075 ON CREEK ROAD EAST OF RTE EXPOS WHEN CENTURION 1-2D (VEHICLE #57-134) WAS STRUCK BY AN IED, VEHICLE SUFFERED DISABLING DAMAGE. THE DRIVER OF THE VEHICLE (BR# ST (b)(3), (b)(6)) WAS KIA. RAN (b)(3), (b)(6)) AND (b)(3), (b)(6)) WERE

(b)(3), (b)(6)

NAME: PFC STANTON JR, KENNY F.  
UNIT: 57<sup>TH</sup> MP CO  
SSN: (b)(3), (b)(6)  
SEX: MALE  
AGE: 20  
RACE: HISPANIC  
POSITION: DRIVER

(b)(3), (b)(6)

- 5. PERSONNEL INVOLVED (NAME, RANK, UNIT, SSN, SEX, AGE, AND RACE, POSITION):
- 4. LOCATION OF INCIDENT: MB (33245 92075), KADIMIYA DISTRICT
- 3. DTG INCIDENT OCCURRED: 132110COCT06
- 2. INCIDENT: IED Strike
- 1. UNIT REPORTING: 372<sup>ND</sup> MP BN POC IS THE BATTLE CPT/BATTLE NCO, VOIP 242-4855

372<sup>ND</sup> MILITARY POLICE BATTALION  
FINAL UPDATE CIR #3040

GROUND EVAC BY CENTURION 1-1 TO 10<sup>TH</sup> CSH FROM THE ABOVE LOCATION. (b)(3), (b)(6) WAS TREATED AT 10<sup>TH</sup> CSH FOR SHRAPNEL WOUNDS TO THE RIGHT CALF, LOWER BACK, AND DEBRIS IN RIGHT EYE. (b)(3), (b)(6) WILL BE DISCHARGED FROM 10<sup>TH</sup> CSH TONIGHT. (b)(3), (b)(6) UNDERWENT SURGERY FOR SHRAPNEL WOUNDS TO THE RIGHT THIGH. (b)(3), (b)(6) WILL STAY OVERNIGHT AT 10<sup>TH</sup> CSH AND BE FLOWN TO BALAAD SOMETIME ON 14 OCT 06. VEHICLE #57-134 IS STAYING AT FOB JUSTICE OVERNIGHT SECURED BY 4-27 FA. VEHICLE WILL BE TOWED TO LIBERTY ON 14 OCT 06. ALL SOLDIERS WERE WEARING PPD.

7. DAMAGE TO GOVERNMENT AND/OR CIVILIAN PROPERTY: ONE M1114 DISABLED.

8. COMMANDER REPORTING: (b)(3), (b)(6)

372<sup>ND</sup> MILITARY POLICE BATTALION  
REDHAND- STEADFAST AND LOYAL  
INITIAL CIR# 3040

1. **UNIT REPORTING:** 372<sup>ND</sup> MP BN POC IS THE BATTLE [REDACTED] (b)(3), (b)(6)  
VOIP [REDACTED] (b)(3), (b)(6)

2. **INCIDENT:** IED STRIKE

3. **DTG INCIDENT OCCURRED:** 132110COCT06

4. **LOCATION OF INCIDENT:** IN VICINITY OF (IVO), MB 359 938  
KADAMIYAH DISTRICT

5. **PERSONNEL INVOLVED** (name, rank, unit, SSN, sex, age, and race):

[REDACTED] (b)(3), (b)(6)

STANTON JR, KENNY F, 20 [REDACTED] (b)(3), (b)(6) PFC (KIA)

**SUMMARY OF INCIDENT:** ON 132110COCT06 WHILE CENTURION 2-1 WAS CONDUCTING A MOUNTED PATROL AT MB 33245 92075 ON CREEK ROAD EAST OF RTE EXPOS WHEN CENTURION 1-2D (VEHICLE #57-134) WAS STRUCK BY AN IED, VEHICLE SUFFERED DISABLING DAMAGE. THE DRIVER OF THE VEHICLE (BR# ST [REDACTED] (b)(3), (b)(6)) WAS KIA. [REDACTED] (b)(3), (b)(6) AND [REDACTED] (b)(3), (b)(6) WERE GROUND EVAC BY CENTURION 1-1 TO 10<sup>TH</sup> CSH FROM THE ABOVE LOCATION. MTF

9. **COMMANDER REPORTING** [REDACTED] (b)(3), (b)(6)



# 372<sup>ND</sup> MILITARY POLICE BATTALION SPOT REPORT

REPORTED BY

(b)(3), (b)(6)

UNIT: 57<sup>TH</sup> MP CO VOIP

(b)(3), (b)(6)

RECEIVED BY:

UNIT: 372 MP BN VOIP

(b)(3), (b)(6)

REPORT DTG: 132130COCT06

SIZE: IED

ACTIVITY: PTT JOINT PATROLS

LOCATION: AL KADHIMYA AT MB33245 92075

UNIFORM: US SOLDIERS

TIME:132110COCT06

EQUIPMENT: N/A

SUMMARY: 372<sup>ND</sup> MP BN RECEIVED THE FOLLOWING INFORMATION,  
CENTURION 11 WHILE ON PATROLS WAS HIT BY AN IED.  
INJURIES 1KIA 2WIA, THE TWO SOLDIERS WERE TAKEN TO 10<sup>TH</sup> CSH

REPORTING COMMANDER:

(b)(3), (b)(6)

132057COCT06, IED, 57 MP CO, 372 MP BN, MB 33245 92075

**SUMMARY:** IED (1 x KIA / 2 x WIA)

**DATE/TIME GROUP:** 132057COCT06

**UNIT/CSIGN:** 57 MP CO / CENTURION 1-2

**MISSION OF UNITS:**  
 T: PATROL  
 P: IP STATION CHECKS

**CREW:** (b)(1)1.4a ALL SYSTEMS FMC  
**CONVOY:** 4XMTT14, 40 METER INTERVAL BETWEEN EA VEH

**TIMELINE OF EVENTS:**  
 132057COCT06: CENTURION 1-2 WAS TRAVELING EAST ON CREEK ROAD WHEN THEY WERE STRUCK WITH AN IED THAT WAS ON THE NORTH SIDE OF THE ROAD. THE IED STRUCK THE THIRD VEHICLE, (57-133), IN THE CONVOY CAUSING DISABLING DAMAGE TO THE VEHICLE. THERE WERE THREE CASUALTIES (1 X KIA) (b)(3), (b)(6) X WIA (b)(3), (b)(6) (b)(3), (b)(6)

2100: CENTURION 1-1 ENROUTE TO CSH WITH 2 X WIA. CENTURION 1-2 ENROUTE TO FOB JUSTICE TOWING 57-133 WITH KIA REMAINS STILL IN THE VEHICLE.

2131: CENTURION 1-1 ARRIVES AT THE CSH WITH TWO WIA CF.

2155: CENTURION 1-2 ARRIVES AT FOB JUSTICE. CENTURION 1-2 MAKES CONTACT WITH MEDICAL PERSONNEL AT THE FOB JUSTICE TMC. THEY EXTRACT THE KIA, (b)(3), (b)(6) FROM THE VEHICLE.

2219 (b)(3), (b)(6) TREATED AT THE CSH AND RELEASED. (b)(3), (b)(6) IS IN THE ORDER GOING SURGERY ON HER LEG.

0015: REMAINS ARE FLOWN TO BIAP BY HELICOPTER. VEHICLE (57-133) WILL REMAIN IN A SECURED AREA WITH 4-27FA AT FOB JUSTICE OVER NIGHT.

**FILE NAME:** CENTURION 1-2 IED 13 OCT 06

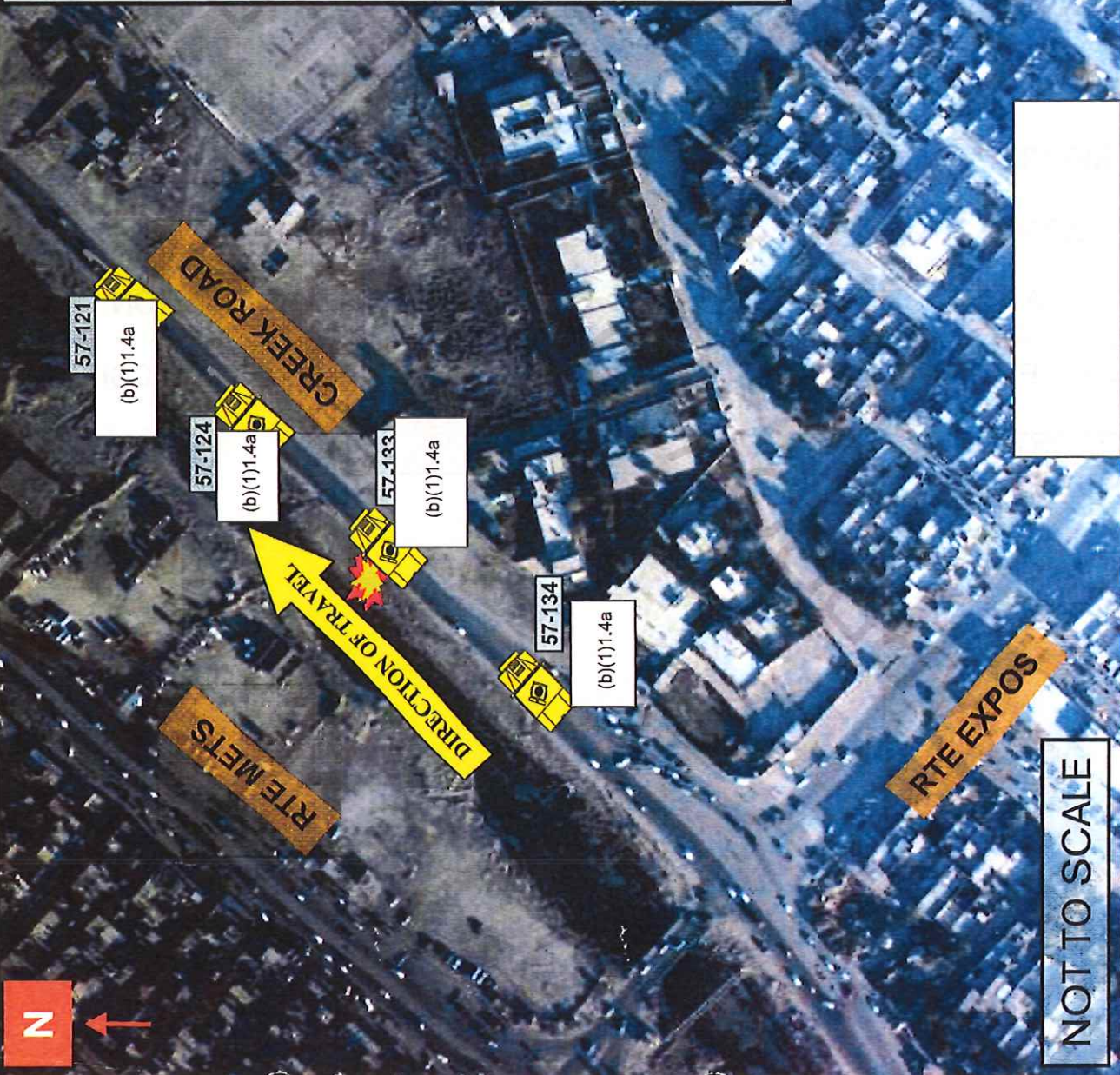

NOT TO SCALE

132057COCT06, IED, 57 MP CO, 372 MP BN, MB 33245 92075

SECRET // REL TO USA IRQ and MCF// For display only to IRQ



RTE METS

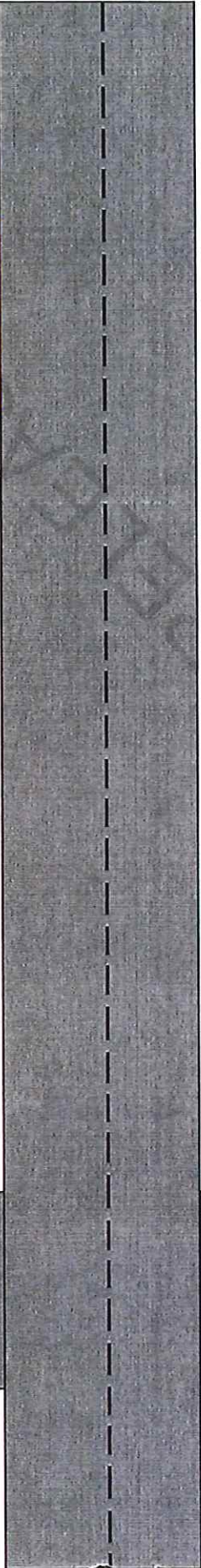

CANAL



CREEK ROAD

(b)(1).4a

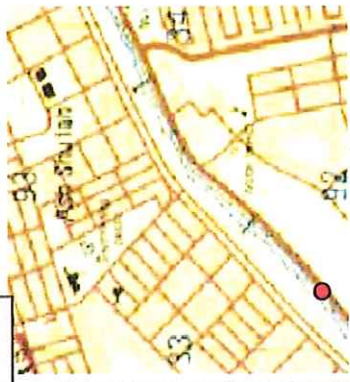

NOT TO SCALE

RTE EXPOS

-----  
(b)(1)1.4a

UNCLASSIFIED

132057COCT06, IED, 57 MP CO, 372 MP BN, MB 33245 92075

SECRET //REL TO USA, IRQ and MCF// For display only to IRQ

1. DRIVER  
PFC STANTON(S) (b)(3), (b)(6)  
KIA  
UPPER BODY AND HEAD  
INJURIES

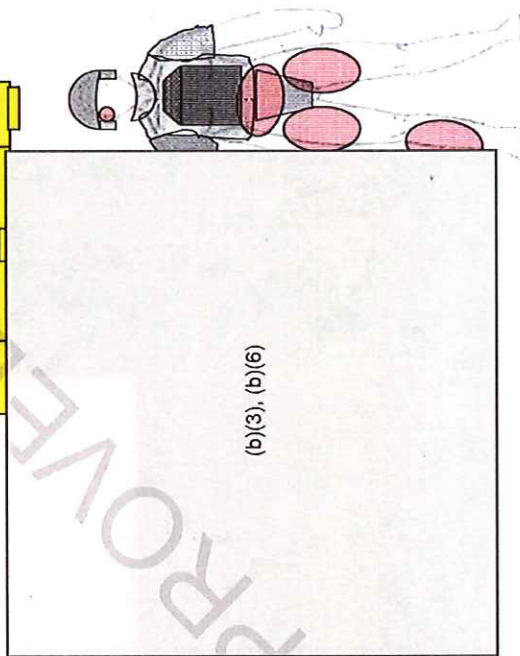
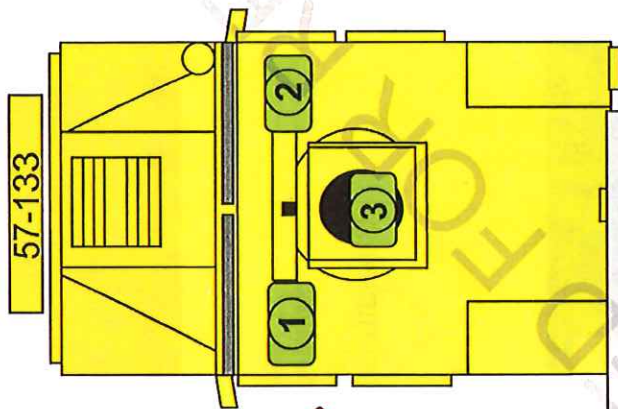
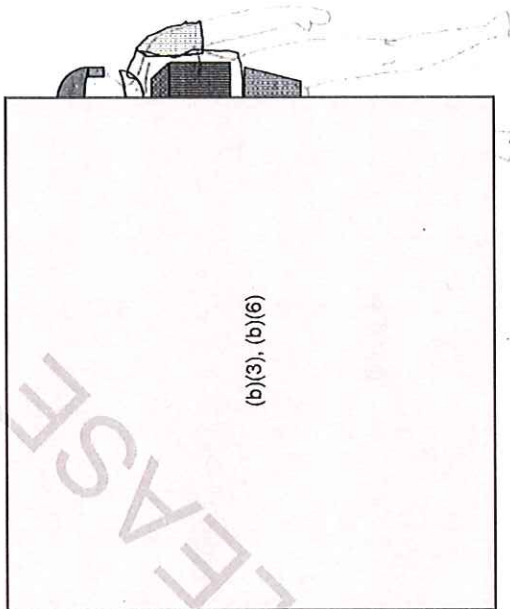

PPE LEVEL: All personnel were in the follow PPE; ACH, Interceptor Body Armor with SAPI plates, throat protector, DAPS, ESBI with SAPI plates and Ballistic Panels, groin protector, gloves, eye protection, and hearing protection.

132057COCT06, IED, 57 MP CO, 372 MP BN, MB 33245 92075

Convoy Planning Tool Version 2.10

- 1. Setup Convoy
- 2. Select Threats
- 3. Modify Convoy
- 4. Print Data
- HELP

**Header** **Footnote**

You can input header information by typing in the space below.  
Only text that shows in this box will appear in the printout.

Preview/Print

View Convoy Spacing Rules

Scale

CREW Range Graf

- Agg DTMF
- LRCT
- FRS
- CAR ALARM KEYLESS ENTRY
- CAR PAGER
- WIRELESS DOORBELL
- CELL PHONE

(b)(1)1.4a

SECRET // REL TO USA IRQ and #ICF# // For display only to IRQ



132057COCT06, IED, 57 MP CO, 372 MP BN, MB 33245 92075



SPOT REPORT CASUALTY VEHICLES IED EVENT DATA IED DEVICE DATA MEDIA

TRACKING NUMBER: 2006-286-233443-0426

Title \*IED ATTK ON 57TH MP CO IN SABIAT (ZONE 28): 1 CF KIA, 2 CF WIA, M1114 DESTROYED

Reporting Unit (undefined) S//REL-MCFI

Classification

SPOTREP

Type of Unit CF

Unit Name

Unit Activity Patrol

DTG of Incident (Local Time) 2006-10-13 20:50

Location (MGRS) 38SMB3324792026

Route

City Sabi`at

Province Baghdad

Region MND-Baghdad

Event Type Explosive Hazard

Event Category IED Explosion

Type of IED Attack

Initial BDA

CF		ISF		CIV		AIF	
WIA	KIA	WIA	KIA	WIA	KIA	WIA	KIA
2	1	0	0	0	0	0	0

AT 132050C OCT 06 IN SABIAT (ZONE 28) IVO 38SMB 33247 92026 2/1 AD REPTS THAT A/1-23IN REPORTS THAT HE WAS CALLED BY CENTURION 1-1 ON BN CMD - THE MP PATROL WAS ATTACKED BY AN IED VIC GRID 38SMB 33055 92089

MP PATROL STATED THEY HAD SUSTAINED 1 X US KIA AND 1 X WIA. THEY STATED THEY WERE ABLE TO SELF-RECOVER 1 DISABLED VEHICLE AND WERE MOVING OUT OF 1-23IN SECTOR TO FOB JUSTICE AND TO THE 28TH CSH.

1-23IN TOC NOT IN CONTACT WITH CENTURION 1-1. THEY HAVE MOVED OUT OF SECTOR (CONFIRMED ON BLUE FORCE)

132230: B/1-23IN LINKED UP WITH MP UNIT ON FOB JUSTICE. THE UNIT REPORTS 1 X KIA AND 2 X WIA WHO WERE EVACUATED TO THE 28TH CSH.

Summary:

4/B/1-23IN MOVING TO ATTACK SITE TO PROVIDE EOD SECURITY FOR POST-BLAST ANALYSIS

MTF

SUMMARY:

- 1 X IED STRIKE
- 1 X US KIA (BR# (b)(3), (b)(6))
- 2 X US WIA (b)(3), (b)(6))
- 1 X M1114 DESTROYED

CLOSED

SECRET // REL TO USA, IRQ and MCFI// For display only to IRQ

~~SECRET//REL TO USA AND MCFI~~

(b)(3), (b)(6)	BATTLE CAPTAIN/NCO, VOI	(b)(3), (b)(6)
----------------	-------------------------	----------------

2. INCIDENT: IED STRIKE **UPDATE** SIGACT #184
3. DTG INCIDENT OCCURRED: 132057COCT06
4. LOCATION OF INCIDENT: MB 33245 92075, KHADIMIYA DISTRICT
5. PERSONNEL INVOLVED (NAME, RANK, UNIT, SSN, SEX, AGE, AND RACE, POSITION):

(b)(3), (b)(6)
----------------

NAME: PFC STANTON JR, KENNY F.  
 UNIT: 57 MP CO (CENTURION 1-2), 372 MP BN  
 SSN: (b)(3), (b)(6)  
 SEX: MALE  
 AGE: 20  
 RACE: HISPANIC  
 POSITION: DRIVER

(b)(3), (b)(6)
----------------

6. SUMMARY OF INCIDENT: APPROXIMATELY 132057COCT06, ELEMENTS OF THE 57 MP CO (CENTURION 1-2), 372 MP BN WERE CONDUCTING A MOUNTED PATROL, VIC MB 33245 92075, ON CREEK ROAD EAST OF RTE EXPOS WHEN CENTURION 1-2D (VEHICLE #57-134) WAS STRUCK BY AN IED BDA. 1 X M1114 DISABLED. THE DRIVER OF THE VEHICLE (BR# (b)(3), (b)(6)) WAS KIA. (b)(3), (b)(6) WERE GROUND EVACED BY CENTURION 1-1 TO 10<sup>TH</sup> CSH FROM THE ABOVE LOCATION. (b)(3), (b)(6) WAS TREATED AT 10<sup>TH</sup> CSH FOR SHRAPNEL WOUNDS TO THE RIGHT CALF, LOWER BACK, AND DEBRIS IN RIGHT EYE. (b)(3), (b)(6) WILL BE DISCHARGED FROM 10<sup>TH</sup> CSH TONIGHT. (b)(3), (b)(6) UNDERWENT SURGERY FOR SHRAPNEL WOUNDS TO THE RIGHT THIGH. (b)(3), (b)(6) WILL STAY OVERNIGHT AT 10<sup>TH</sup> CSH AND BE FLOWN TO BALAAD ON 14 OCT 06. VEHICLE #57-134 WILL REMAIN AT FOB JUSTICE OVERNIGHT WITH SECURITY PROVIDED BY 4-27 FA. VEHICLE WILL BE TOWED TO LIBERTY ON 14 OCT 06. ALL SOLDIERS WERE WEARING PPD. REMAINS OF BR# ST (b)(3), (b)(6) WERE REMOVED FROM THE VEHICLE BY PERSONNEL FROM THE FOB JUSTICE TMC AND WERE FLOWN TO MORTUARY AFFAIRS AT BIAP.
7. DAMAGE TO GOVERNMENT AND/OR CIVILIAN PROPERTY: 1 x M1114 DISABLED.
8. INJURY TO PERSONNEL: 1 X US KIA, 2 X US WIA.



132057COCT06, IED, 57 MP CO, 372 MP BN, MB 33245 92075 SIGACT #184 UPDATE

SUMMARY: IED (1 X KIA / 2 X WIA)

DATE/TIME GROUP: 132057COCT06

UNIT(S) SIGN: 57 MP CO / CENTURION 1-2

MISSION OF UNITS:

T: PATROL  
P: IP STATION CHECKS

CREW: (b)(1)1.4a ALL SYSTEMS FMC  
CONVOY: 4XMT114, 40 METER INTERVAL BETWEEN EA VEH

TIMELINE OF EVENTS:

132057COCT06: CENTURION 1-2 WAS TRAVELING EAST ON CREEK ROAD WHEN THEY WERE STRUCK WITH AN IED THAT WAS ON THE NORTH SIDE OF THE ROAD. THE IED STRUCK THE THIRD VEHICLE, (57-134), IN THE CONVOY CAUSING DISABLING DAMAGE TO THE VEHICLE. THERE WERE THREE CE CASUALTIES (1 X KIA (S)(3), (b)(6) X WIA (b)(3), (b)(6) (b)(3), (b)(6))

2100: CENTURION 1-1 ENROUTE TO CSH WITH 2 X WIA. CENTURION 1-2 ENROUTE TO FOB JUSTICE TOWING 57-134 WITH KIA REMAINS STILL IN THE VEHICLE.

2131: CENTURION 1-1 ARRIVES AT THE CSH WITH TWO WIA CF.

2155: CENTURION 1-2 ARRIVES AT FOB JUSTICE. CENTURION 1-2 MAKES CONTACT WITH MEDICAL PERSONNEL AT THE FOB JUSTICE TMC. THEY EXTRACT THE KIA, (S)(3), (b)(6) FROM THE VEHICLE.

2219 (b)(3), (b)(6) (RE)ATED AT THE CSH AND RELEASED (b)(3), (b)(6) IS IN THE BR UNDER GOING SURGURY ON HER LEG.

0015: REMAINS ARE FLOWN TO BIAP BY HELICOPTER. VEHICLE (57-134) WILL REMAIN IN A SECURED AREA WITH 4-27FA AT FOB JUSTICE OVER NIGHT.

FILE NAME: CENTURION 1-2 IED, 13 OCT 06

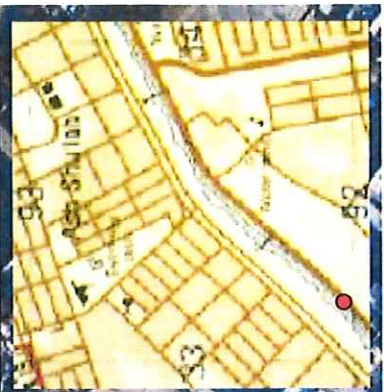

132057COCT06, IED, 57 MP CO, 372 MP BN, MB 33245 92075

SECRET // REL TO USA, IRQ, and MCF // For display only to IRQ



RTE METS

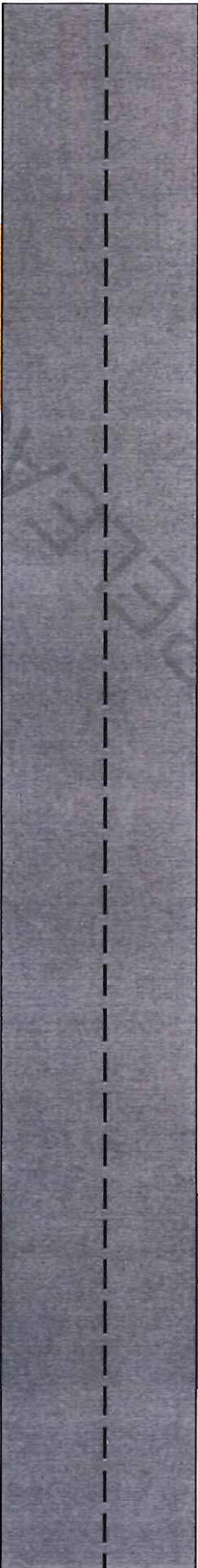

(b)(1)1.4a



GREEN ROAD

NOT TO SCALE

RTE EXPOS

-----  
(b)(1)1.4a

UNCLASSIFIED

132057COCT06, IED, 57 MP CO, 372 MP BN, MB 33245 92075

SECRET //REL TO USA, IRQ and MCF// For display only to IRQ

1. DRIVER  
PFC STANTON(S (b)(3), (b)(6))  
KIA  
UPPER BODY AND HEAD INJURIES

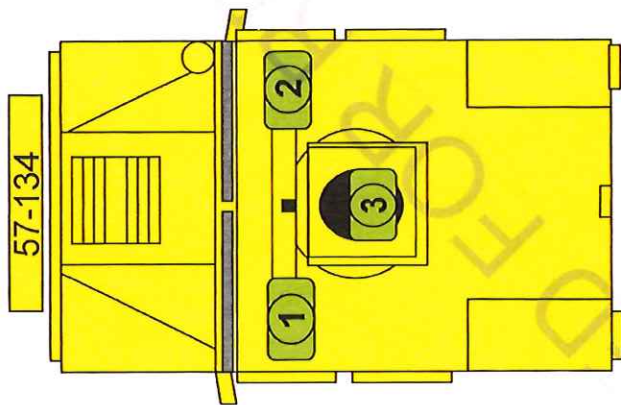
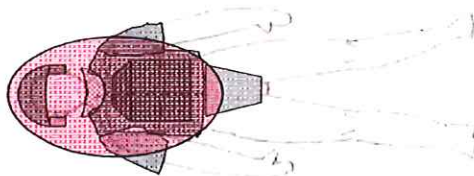

57-134

(b)(3), (b)(6)

(b)(3), (b)(6)

132057COCT06, IED, 57 MP CO, 372 MP BN, MB 33245 92075

Convo Planning Tool Version 2.10

- 1. Setup Convo
- 2. Select Threats
- 3. Modify Convo
- 4. Print Data
- HELP

Preview/Print

Header Footnote

You can input header information by typing in the space below. Only text that shows in this box will appear in the printout.

View Convo Spacing Rules

Scale

CREW Range

Agg DMF  
LRCT  
FRS  
CAR ALARM KEYLESS ENTRY  
CAR PAGER  
WIRELESS DOORBELL  
CELL PHONE

1 2 3 4

SECRET // REL TO USA, IRQ and MOCF// For display only to IRQ

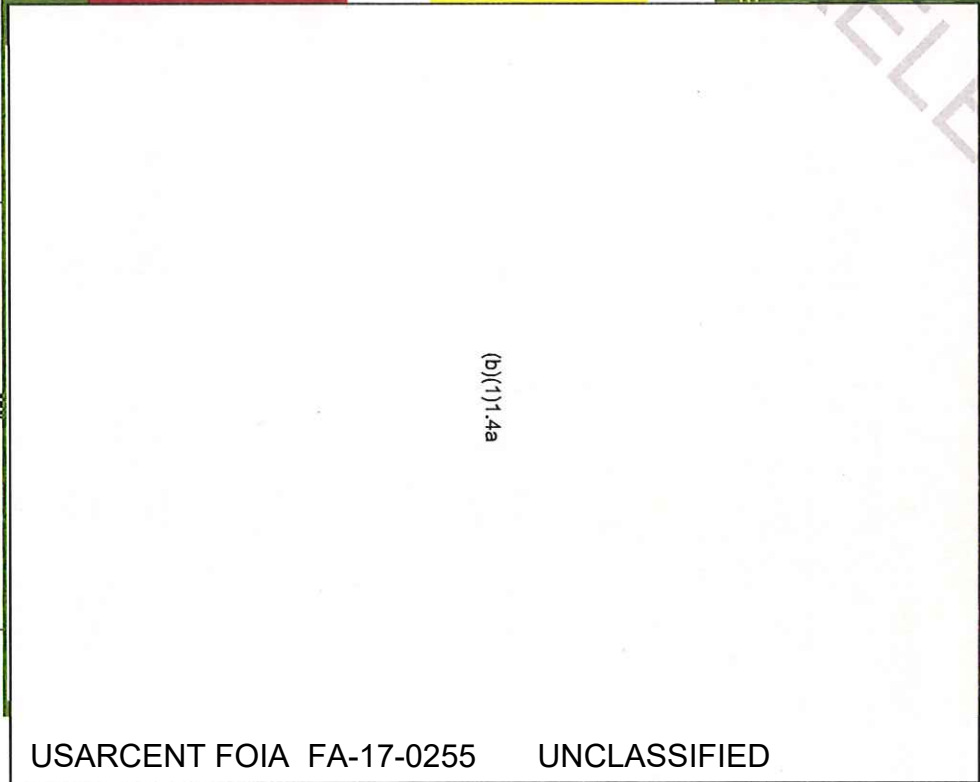

(b)(1)1.4a

UNCLASSIFIED